

**Military Technical College
Kobry El-Kobbah,
Cairo, Egypt**



**9th International Conference
on Civil and Architecture
Engineering**

ICCAE-5-2012

Structural Systems Effect on Stability of Ferries Using 3D FEM

Y. A. Khalifa*, M. M. Abdelwahab*, and Adel Helmy Salem*

ABSTRACT

Recently, The military load capacity 70ton (MLC70) became the designable load for military bridges after the upgrading of the military vehicles and tanks according to military code. The analysis of pontoon bridges requires the analysis of units of the floating bridge in separated stages as a unique pontoon, bridge bay (ferry) and finally the bridge as a whole, taking in consideration for each stage the critical cases of loading and stability limits.

This paper presents a study for the best method for bridge upgrading from MLC 60 to MLC70 using 3D FEM by ANSYS software package version 11.0 for a different five proposals for the development of the existing ferries, taking in consideration the critical vehicle positions during loading at the middle of the water barrier.

KEYWORDS:

Pontoon bridge; 3D FEM; Ferry; Military Load Capacity 70ton (MLC70).

1. INTRODUCTION

Floating bridges have a lot of advantages, as it may be the most economic and applicable solutions in civilian water crossing problems. It is the main method for crossing troops in military operations. Military floating bridges are movable and quickly installed within dependent of water depth or type of soil of water bed.

3D FEM is used to analyze the five developed ferries in addition to the existing ferry. Critical cases of loading are considered at middle of the water barrier. A comparison is done between the developed ferries, concluding the most stable and applicable modification system.

2. PROBLEM STATEMENT

The main objective of this paper is to increase the floating capacity of the old existing floating ferry (MLC60) to reach the nowadays designable load (MLC70) with respect to the stability point of view and the limits of the military code.

* Military Technical College, Cairo, Egypt, khalifa_yaser@yahoo.com.

3. MODEL DESCRIPTION

The dimensions of the old existing ferry are 8.0 ms wide, 0.75 ms height and 22.5 ms long. The modification in the ferry includes the height, the width as well as the geometric configuration of the ferry. The ferry consists of five replicated pontoons which are rigidly connected. Each pontoon consists of two inner pontoons and two outer (bow) pontoons 2.0 ms wide each.

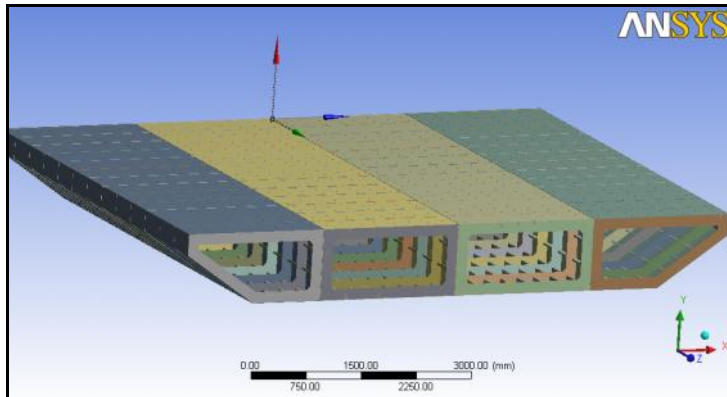

Fig.(3.1) Perspective View for the Pontoon and its inner construction .

4. LOAD DEFINITION

The traffic load capacity is MLC 70 which refers to the military tank . Its actual load is 63.5ton which is distributed on two side chains 4.5ms long, 0.5ms wide and inner space of 2ms. The load on the chains is modeled as pressure acting into the same contact area between the tank and ferry's surface, taking in consideration the impact effect as 30% added to the static load [8].

5.SUGETTION OF FIVE DIFFERENT MODIFICATIONS

In order to study the best modification required for upgrading the existing bridge from MLC 60 to MLC70 different modifications were suggested , either by increasing the depth or width over all the ferry or in specified positions or in its geometric configuration, such that all the suggested proposals have the same floating capacity. The first modification (type 1) carried out by increasing the height of the ferry from 0.75 ms to 1.0 ms all over the length as shown in fig. (5.1). The second modification (type 2) the height increased to be 1.0m and increasing width by adding an inverted U-frame at mid width every cross frame to get 9.0ms width as shown in fig. (5.2). The third one (type 3) done by increasing depth 0.5m at each side to get depth 1.25ms over a width of 1.0m as shown in fig. (5.3). the fourth modification (type 4) is done by increasing width to be 10.0ms with same depth 0.75m over all as shown in fig. (5.4). The final modification (type 5) is done by increasing width at ferry's edges only to be 12.0ms with same depth 0.75m over all as shown in fig. (5.5).

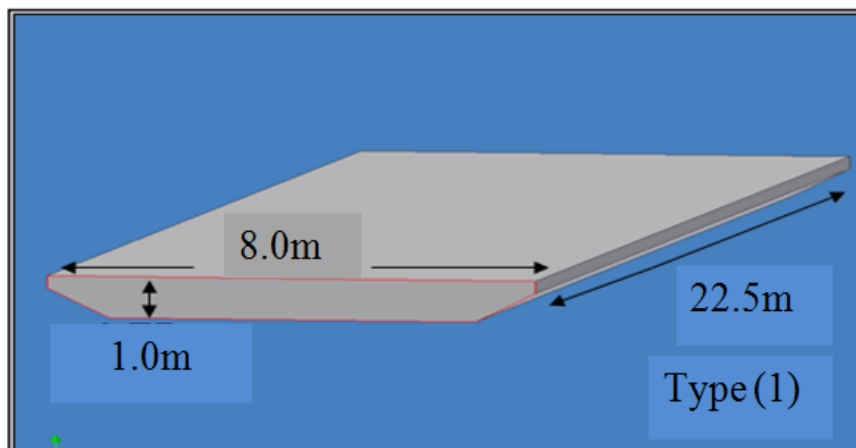

Fig.(5.1) Increasing height to 1.0m with same width 8.0m over all .

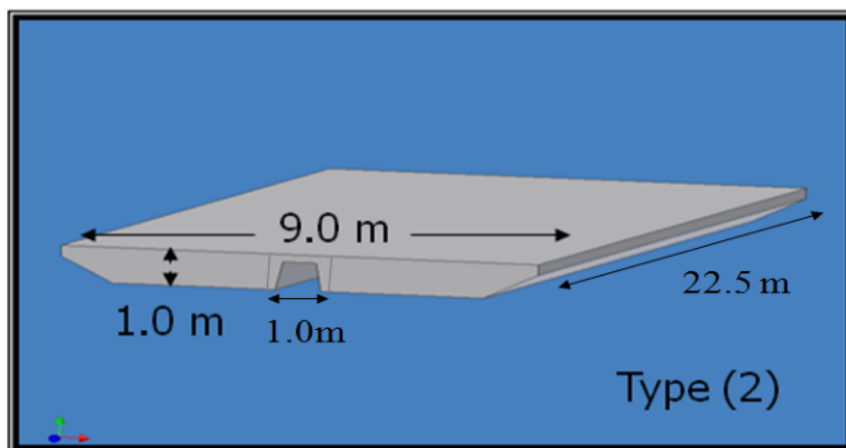

Fig.(5.2) Increasing height to 1.0m and increasing width by adding an inverted U -frame at mid width every cross frame to get 9.0ms .

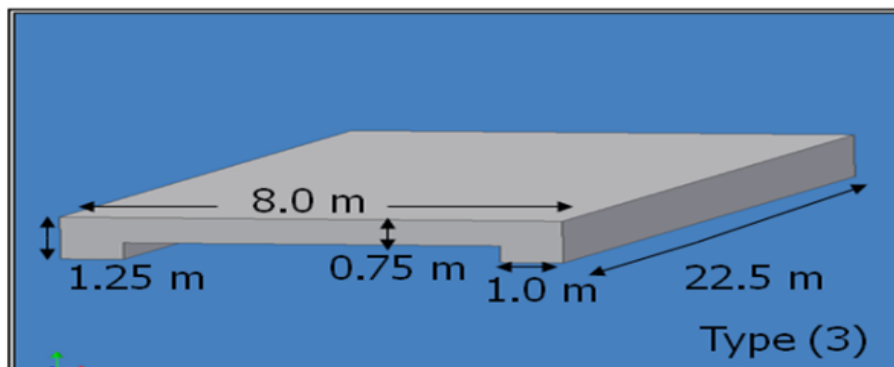

Fig.(5.3) Increasing depth 0.5m at each side to get depth 1.25ms over a width of 1.0m.

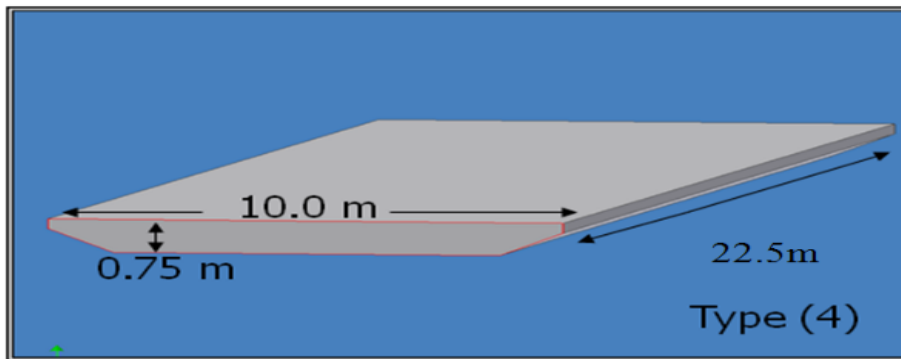

Fig.(5.4) Increasing width to be 10.0ms with same depth 0.75m over all.

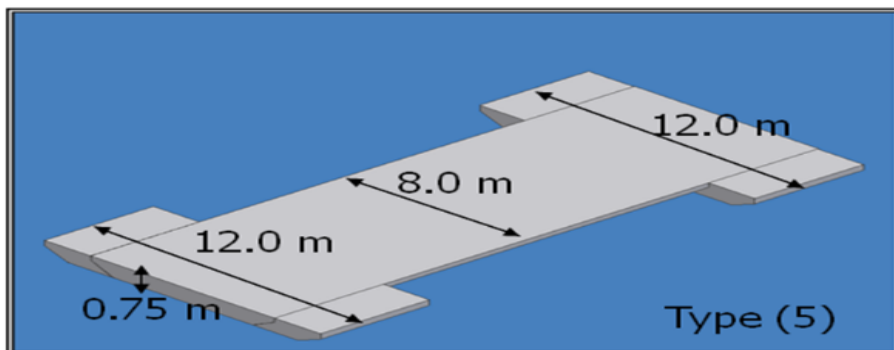

Fig.(5.5) Increasing width at ferry's edges only to be 12.0ms with same depth 0.75m over all.

6. 3D FEM FOR OLD FERRY AND THE NEW FIVE PROPOSALS

The analysis of ferry is done using ANSYS software version 11.0, where the cover steel sheet and all internal members are modeled using shell elements with 4mms thickness. The MLC70 is simulated as pressure on contact area (1.8×10^5 Pa). Elastic supports are applied on the contact lower surface of the ferry, where the stiffness of the elastic support is computed using three curves which are the draft -water line area curve ,draft-displaced volume curve and finally stiffness -draft curve. All those curves are drawn by the designer for each model separately in order to determine the accurate value of the stiffness.

7. Non-Linear Analysis For Modified Ferries Under MLC 70 Loading

Water crossing with heavy load such as tank of MLC 70 must be done after loading near the shore and the load must be concentric (transverse eccentricity $e_t = 0.0$, longitudinal eccentricity $e_l = 0.0$) to ensure the safety and stability of the ferry. For the analysis and comparison between the different proposals, other loading cases are considered including longitudinal and transverse eccentric cases of loading which shall be discussed in the following sections.

7.1 Concentric MLC70 loading

The calculated drafts of the five new proposals as shown in figures (7.1.1),(7.1.2),(7.1.3),(7.1.4) and (7.1.5) are found to be 70cms for both type (1) and (2) which present 70% of its height, 90cms for type (3) which present 72% of its height, 53.5cms for type (4) which present 70.6% of its height, 90cms for type (5) which present 72% of its height. It is clear that all values of the draft for the concentric loading

are nearly equal and safe as they do not exceed 80% of the height. For the same load on the old existing ferry (type 6) the draft is found to be equal 64cms, which presents 85.3% of the height i.e. not safe.

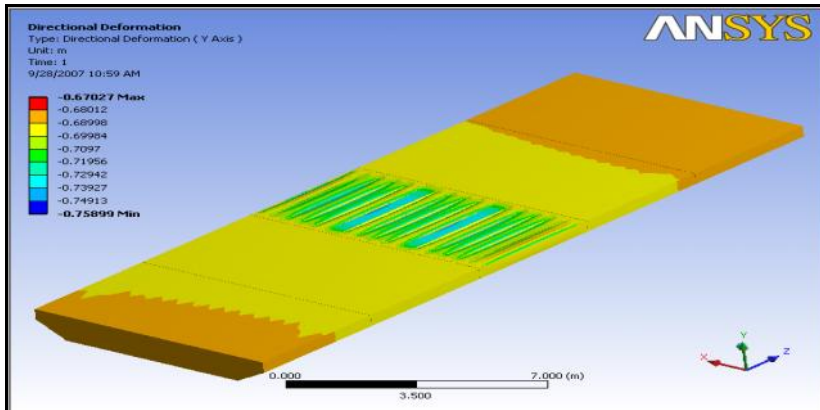

Fig.(7.1.1) Draft of type (1) ferry under concentric load

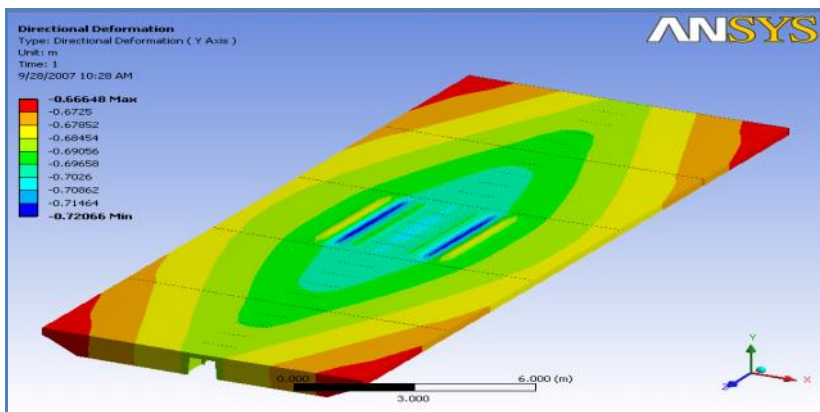

Fig.(7.1.2) Draft of type (2) ferry under concentric load

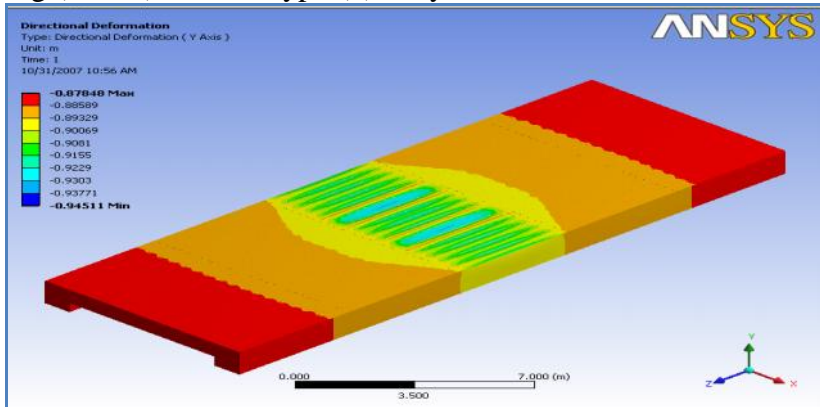

Fig.(7.1.3) Draft of type (3) ferry under concentric load

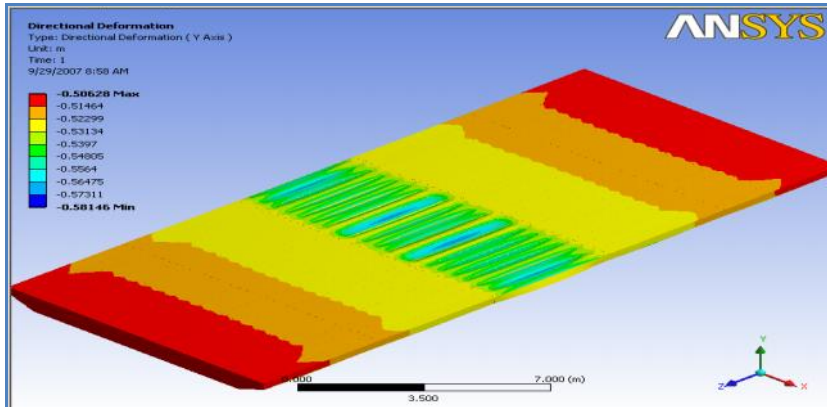

Fig.(7.1.4) Draft of type (4) ferry under concentric load

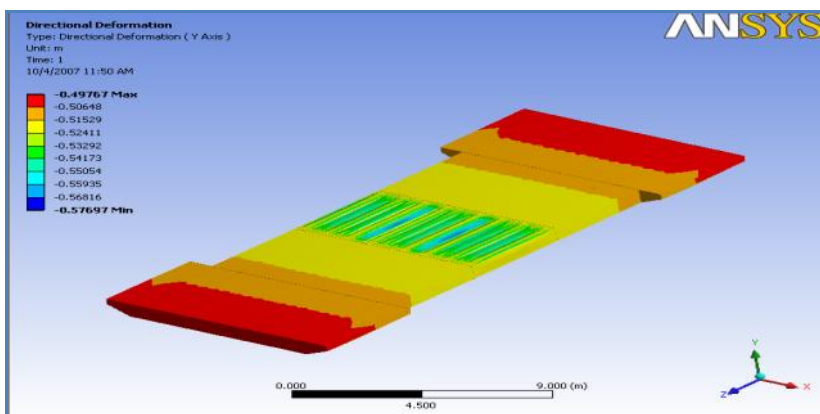

Fig.(7.1.5) Draft of type (5) ferry under concentric load

In order to make a comparison between the new five modified ferries and the old (existing) ferry, The same loading cases are applied on the old ferry in order to determine the percentage of enhancement that has been reached.

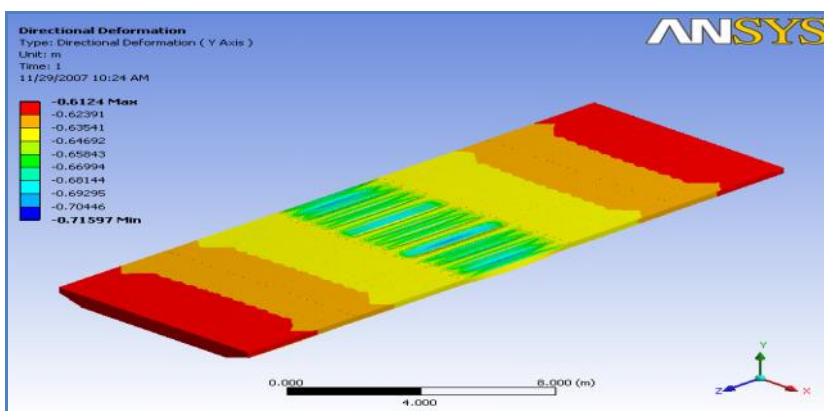

Fig.(7.1.6) Draft of type (6) ferry under concentric load

Selected longitudinal and transverse sections are chosen for purpose of stability comparison for the modified ferries as shown in figure (7.1.7). The draft diagrams along the sections are shown in the following figures (7.1.8) to (7.1.12).

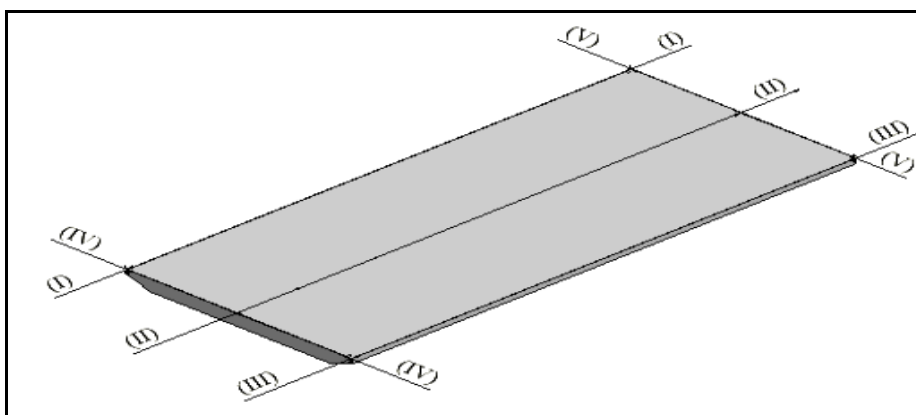

Figure (7.1.7) Five selected sections were chosen to represent draft values for all modified ferries

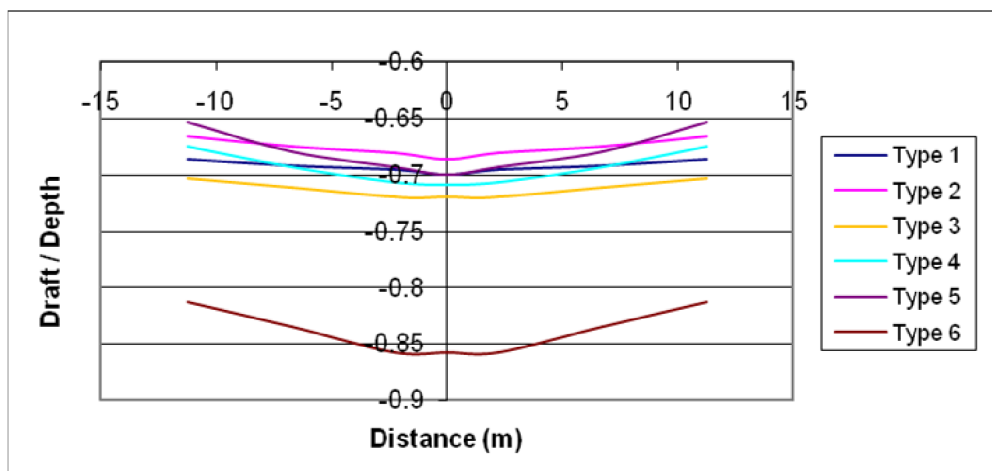

Figure (7.1.8) Draft/depth-distance of the ferries under concentric load at section (I-I)

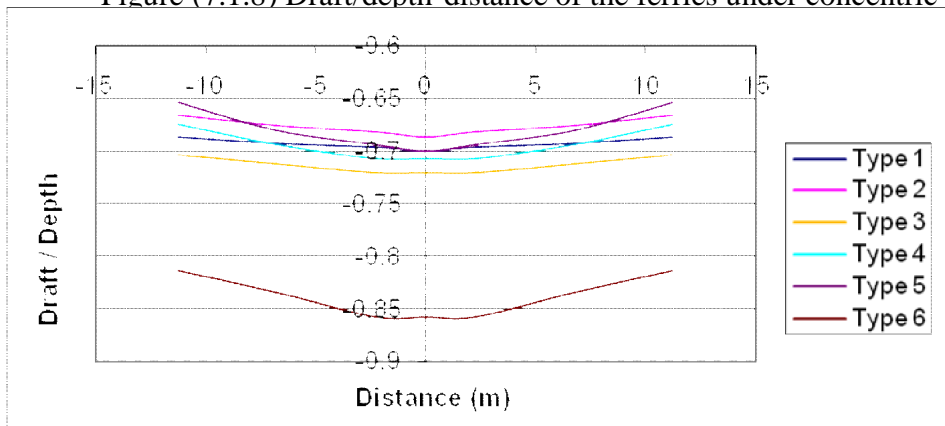

Figure (7.1.9) Draft/depth-distance of the ferries under concentric load at section (II-II)

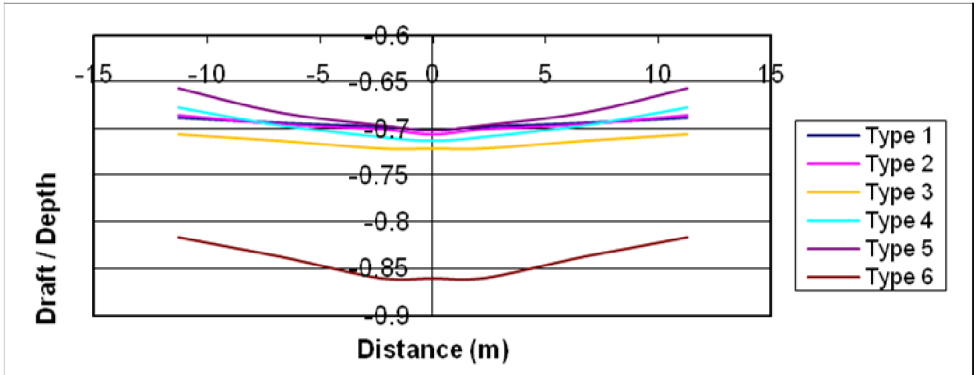

Figure (7.1.10) Draft/depth-distance of the ferries under concentric load at section (III -III)

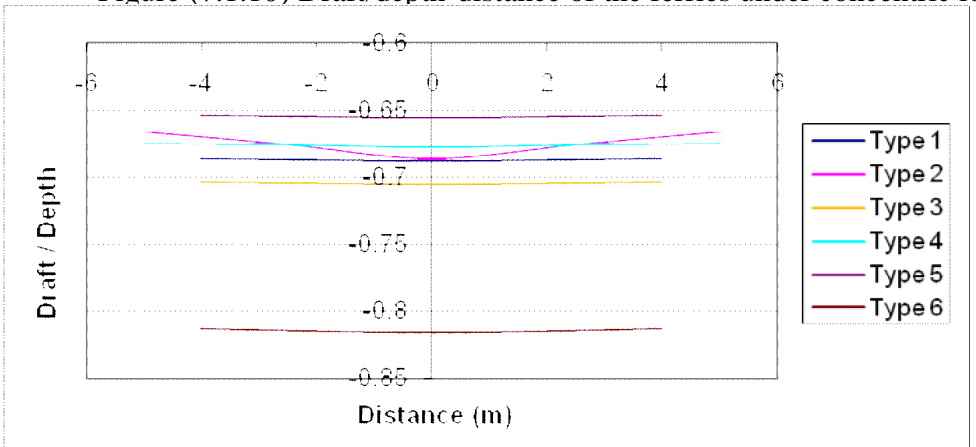

Figure (7.1.11) Draft/depth-distance of the ferries under concentric load at section (IV -IV)

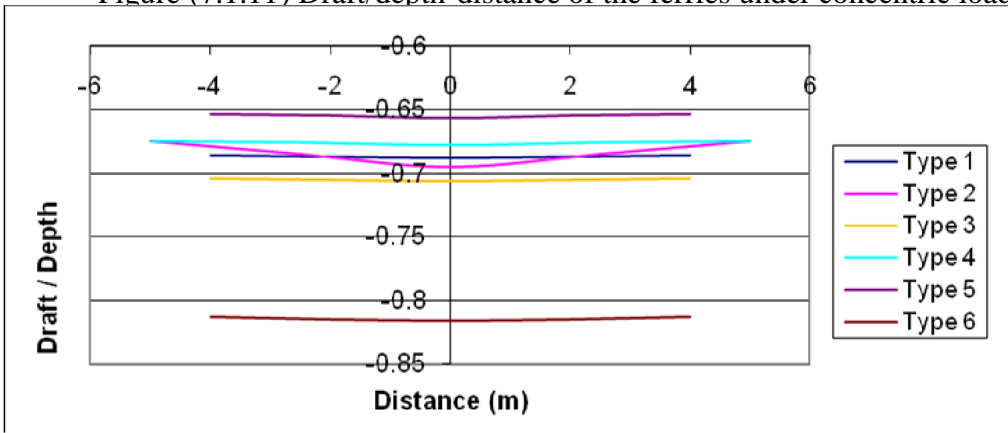

Figure (7.1.12) Draft/depth-distance of the ferries under concentric load at section (V -V)

7.2 Longitudinal eccentric MLC70 loading

For longitudinal eccentric loading, two cases were studied as shown in figure (7.2.1) with eccentricity 4.5ms and 9.0ms, as the tank position is on the first or second pontoon along the ferry.

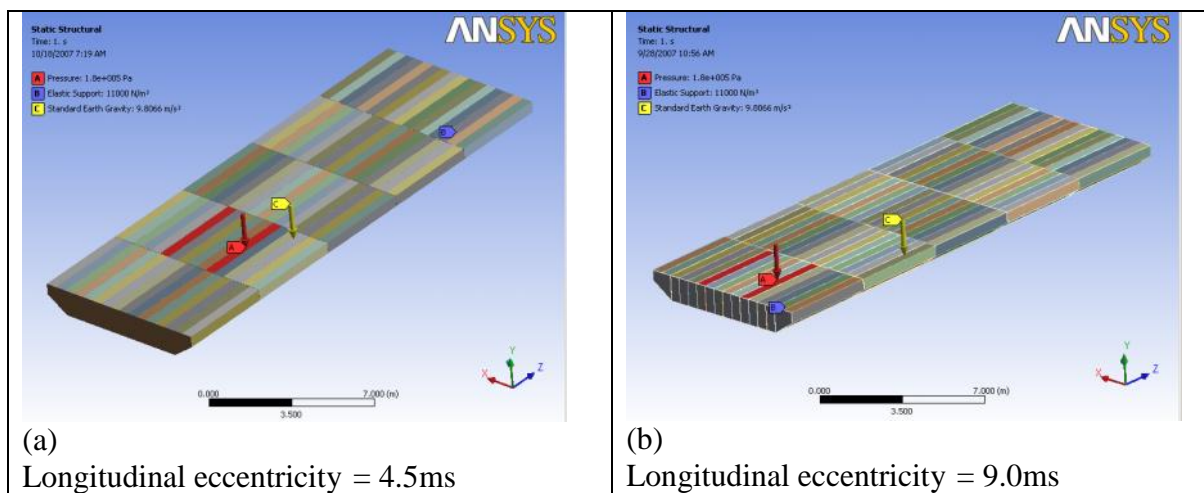

Figure (7.2.1) Longitudinal eccentric loading cases

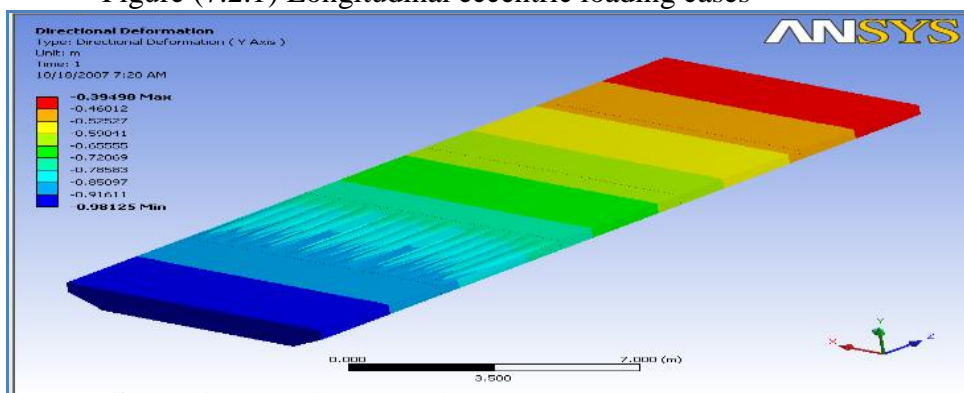

Figure (7.2.2) Draft of type 1 ferry under eccentricity of 4.5ms

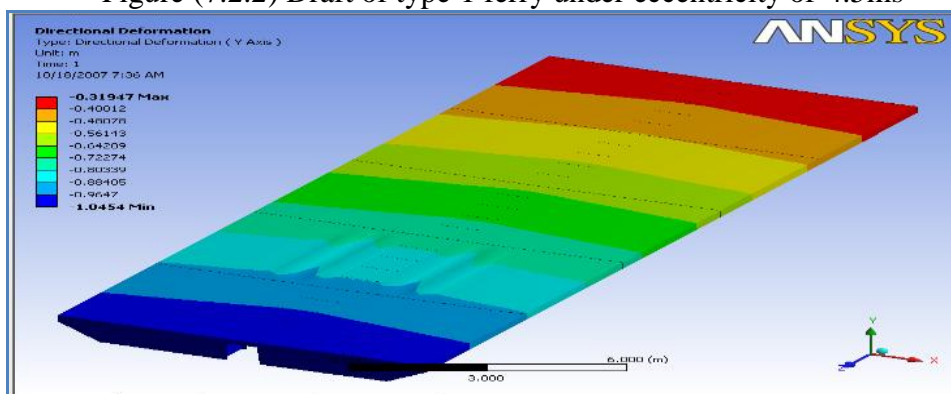

Figure (7.2.3) Draft of type 2 ferry under eccentricity of 4.5ms

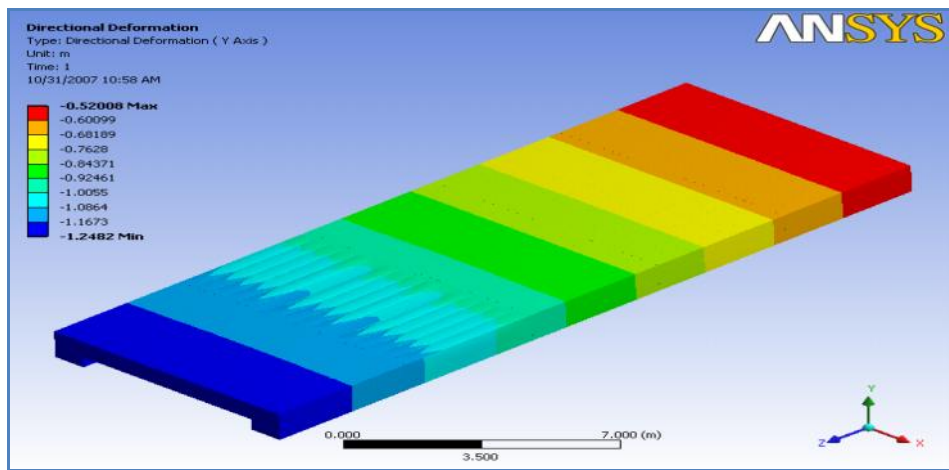

Figure (7.2.4) Draft of type 3 ferry under eccentricity of 4.5ms

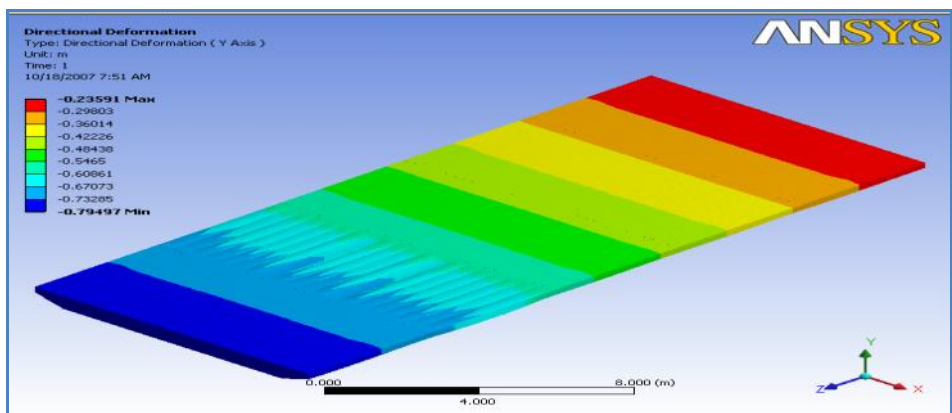

Figure (7.2.5) Draft of type 4 ferry under eccentricity of 4.5ms

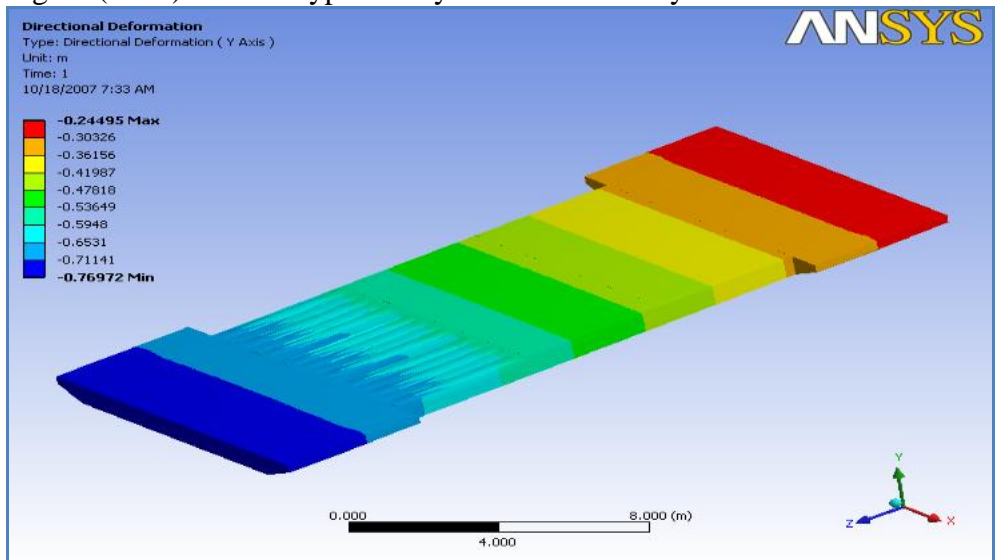

Figure (7.2.6) Draft of type 5 ferry under eccentricity of 4.5ms

The calculated drafts of the five ferry modifications under longitudinal eccentricity of 4.5ms as shown in figure (7.2.2), (7.2.3), (7.2.4), (7.2.5) and (7.2.6) are found to be 98cms for type (1) which represents 98% of its height, 104cms for type (2) which represents 104% of its height, 124cms for type (3) which represents 94% of its height, 79cms for type (4) which represents 105% of its height, 77cms

for type (5) which represents 102% of its height. It is clear that all the values of draft for the eccentric loading are unsafe as they exceed 80% of the height. But, as stated before these cases of loading do not occur at real operation, it is just for stability analysis. Here, the difference between the draft values is larger, compared with the case of concentric loading. Figures from (7.2.7) to (7.2.11) show draft/depth-distance of the existing and modified ferries under longitudinal eccentricity of 4.5 ms.

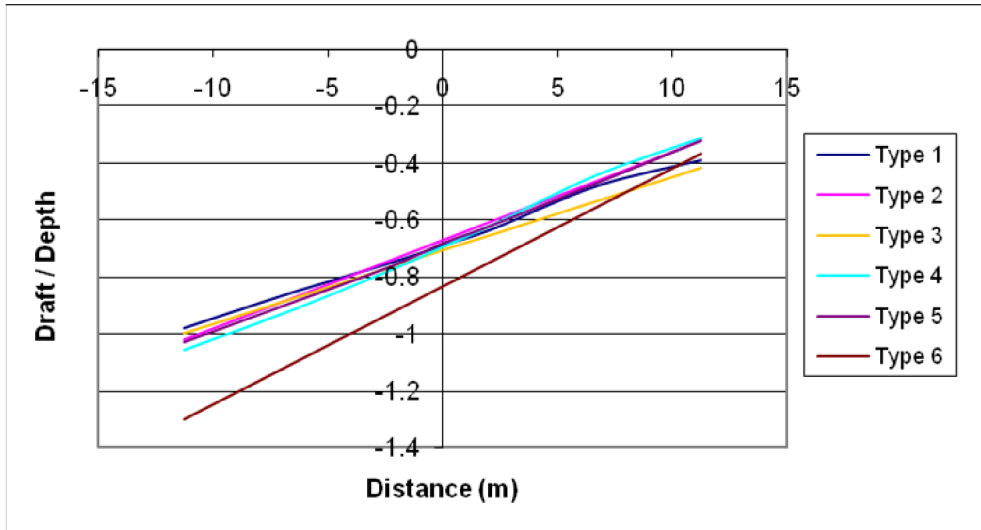

Figure (7.2.7) Draft/depth-distance of the existing and modified ferries under longitudinal eccentricity of 4.5ms at section (I-I)

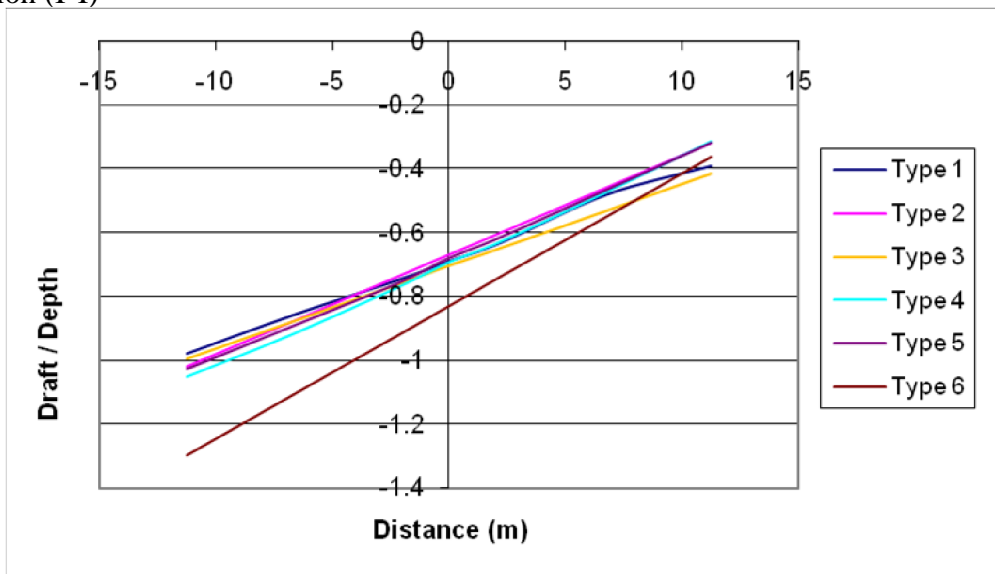

Figure (7.2.8) Draft/depth-distance of the existing and modified ferries under longitudinal eccentricity of 4.5ms at section (II-II)

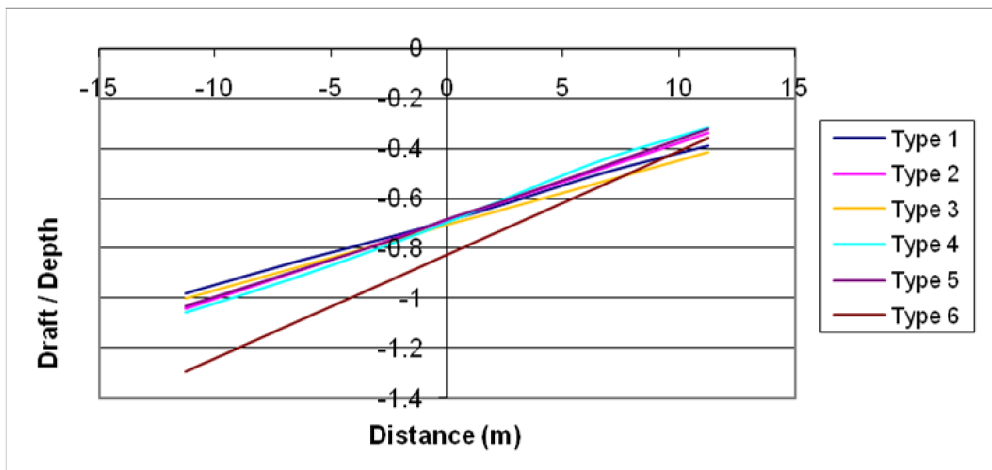

Figure (7.2.9) Draft/depth-distance of the existing and modified ferries under longitudinal eccentricity of 4.5ms at section (III-III)

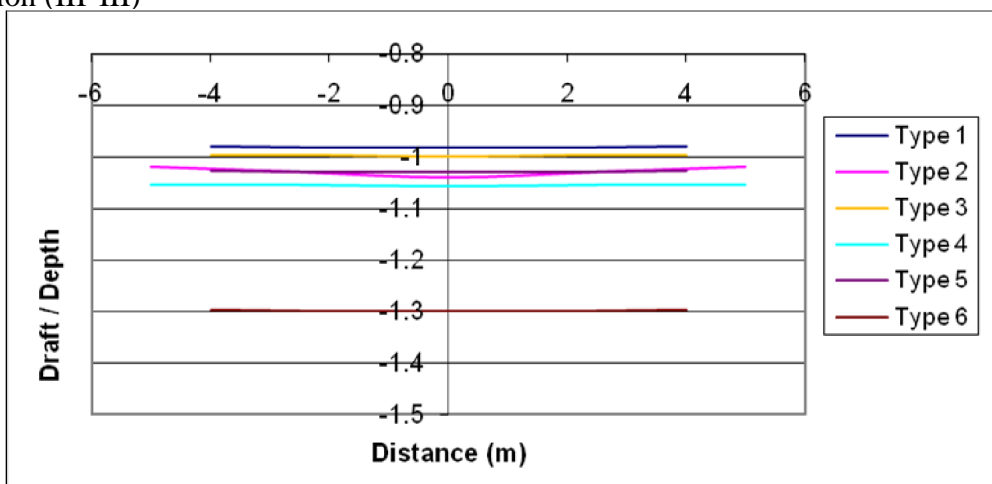

Figure (7.2.10) Draft/depth-distance of the existing and modified ferries under longitudinal eccentricity of 4.5ms at section (IV-IV)

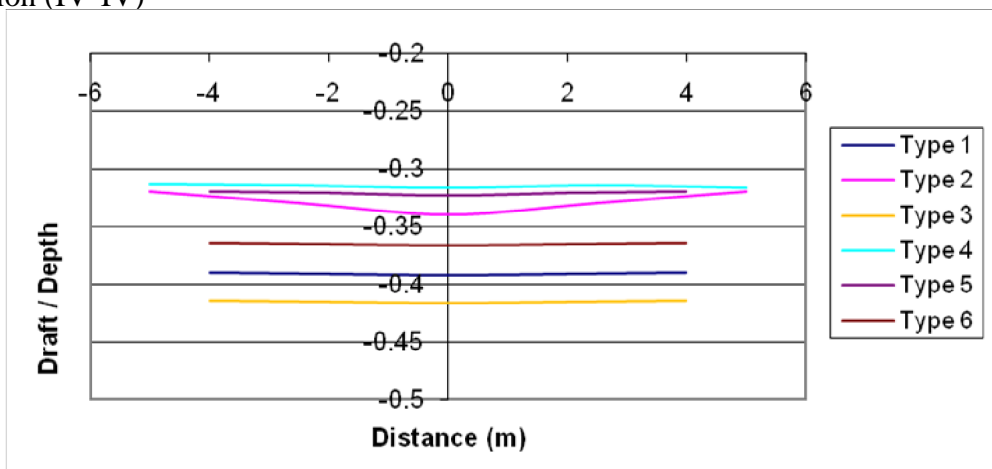

Figure (7.2.11) Draft/depth-distance of the existing and modified ferries under longitudinal eccentricity of 4.5ms at section (V-V)

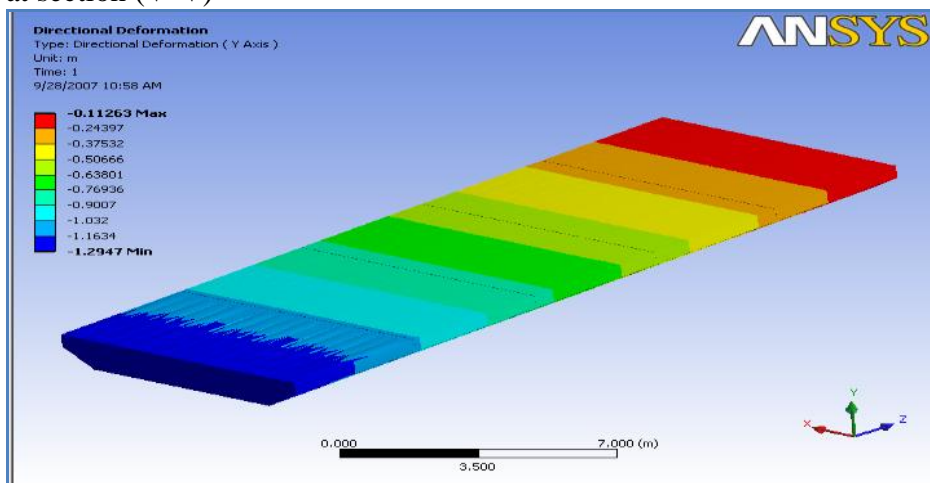

Figure (7.2.12) Draft of type 1 ferry under eccentricity of 9.0ms

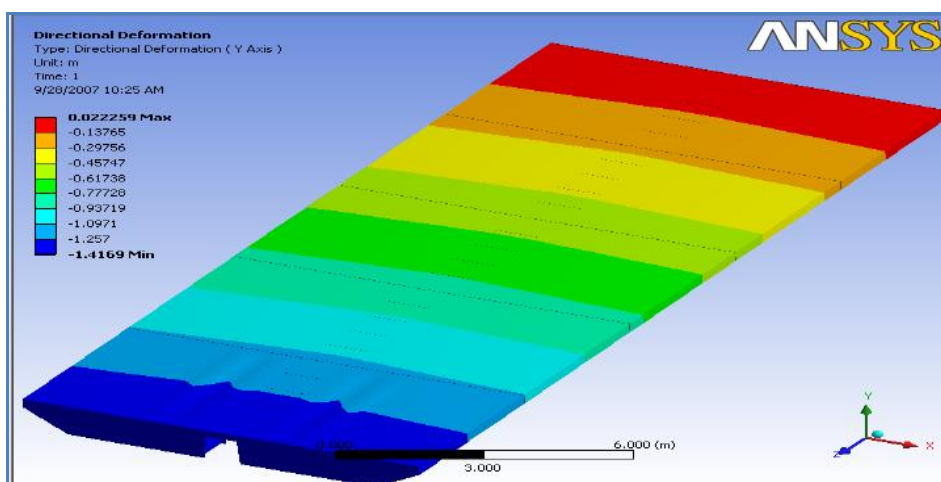

Figure (7.2.13) Draft of type 2 ferry under longitudinal eccentricity of 9.0ms

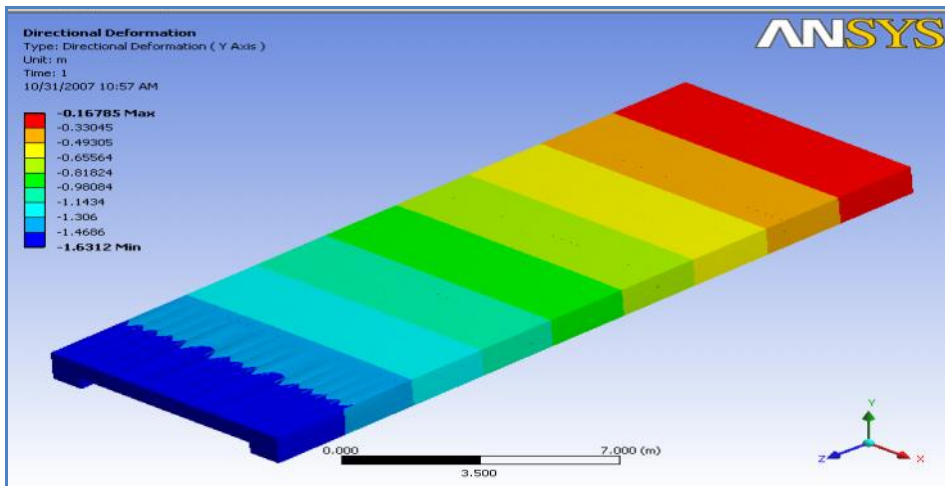

Figure (7.2.14) Draft of type 3 ferry under longitudinal eccentricity of 9.0ms

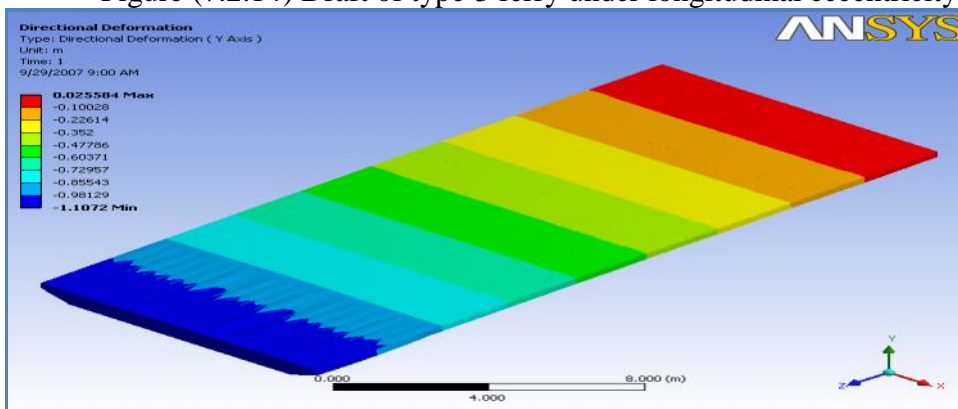

Figure (7.2.15) Draft of type 4 ferry under longitudinal eccentricity of 9.0ms

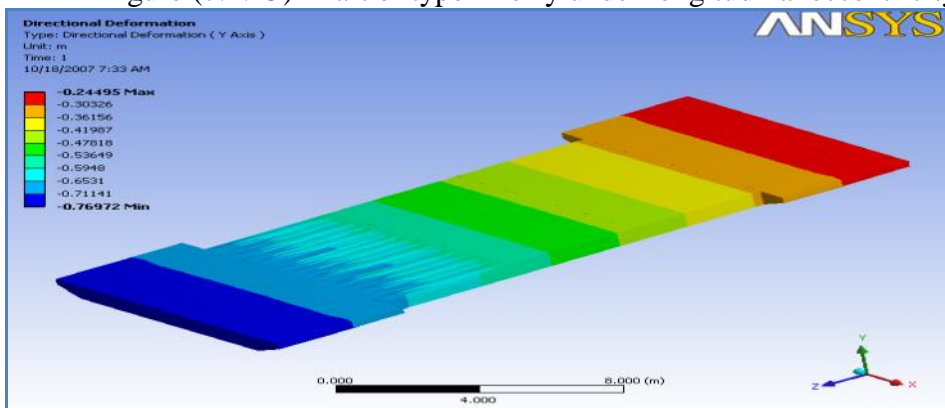

Figure (7.2.16) Draft of type 5 ferry under longitudinal eccentricity of 9.0ms

As shown in figures (7.2.12), (7.2.13), (7.2.14), (7.2.15) and (7.2.16), the drafts of the five proposals under longitudinal eccentricity of 9.0ms are found to be 129cms for type (1) which present 129% of its height, 142cms for type (2) which present 142% of its height, 163cms for type (3) which present 130% of its height, 110cms for type (4) which present 147% of its height, 106cms for type (5) which present 141% of its height. Figures from (7.2.17) to (7.2.21) show draft/depth-distance of the existing and modified ferries under longitudinal eccentricity of 9.0 ms.

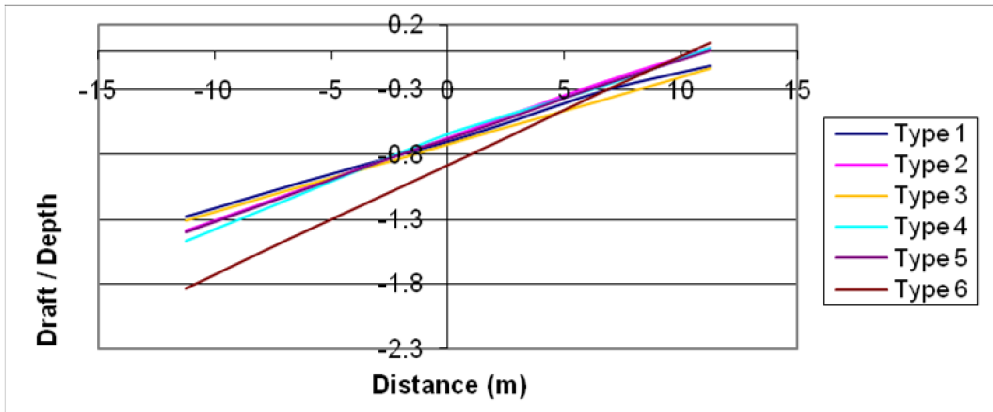

Figure (7.2.17) Draft/depth-distance of the existing and modified ferries under longitudinal eccentricity of 9.0ms at section (I-I)

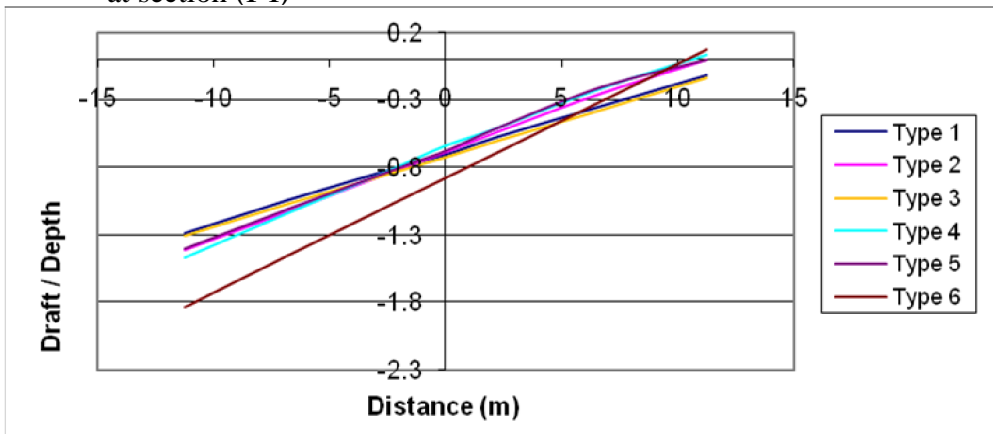

Figure (7.2.18) Draft/depth-distance of the existing and modified ferries under longitudinal eccentricity of 9.0ms at section (II-II)

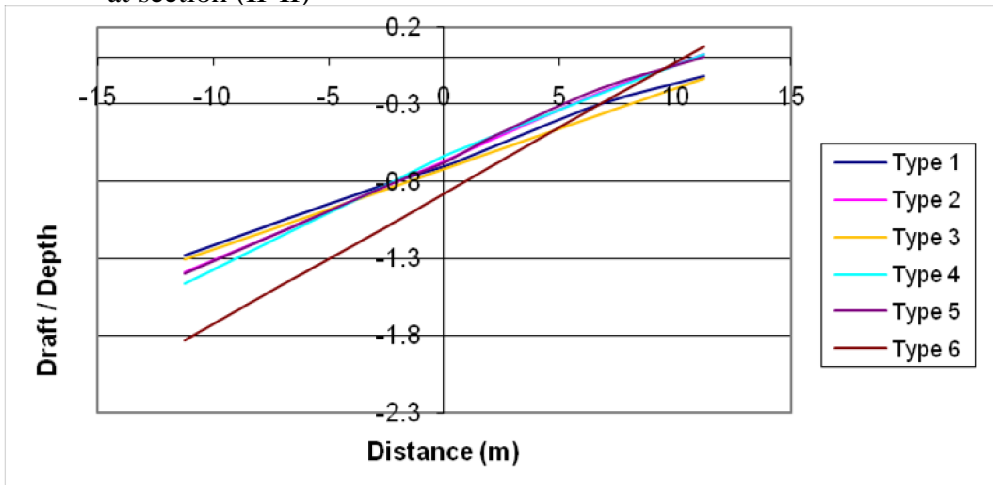

Figure (7.2.19) Draft/depth-distance of the existing and modified ferries under longitudinal eccentricity of 9.0ms at section (III-III)

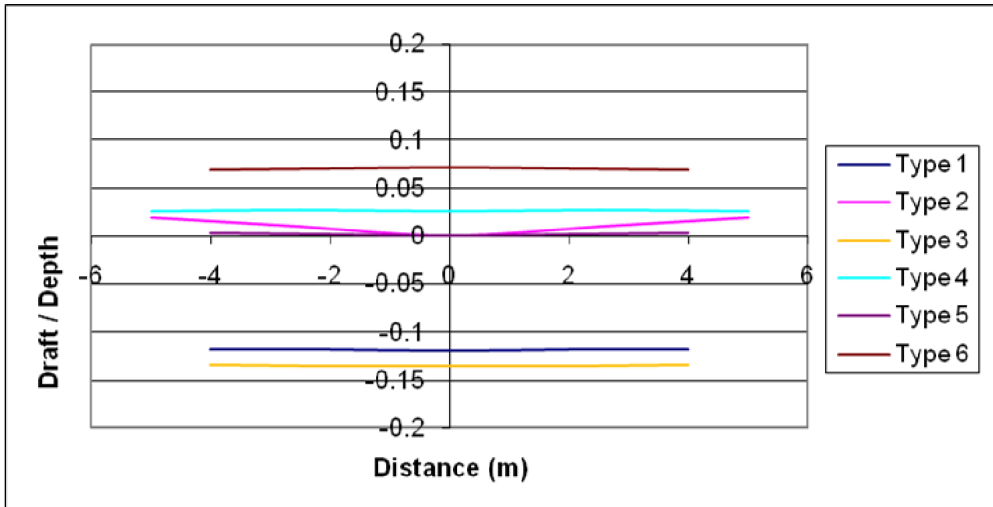

Figure (7.2.20) Draft/depth-distance of the existing and modified ferries under longitudinal eccentricity of 9.0ms at section (IV-IV)

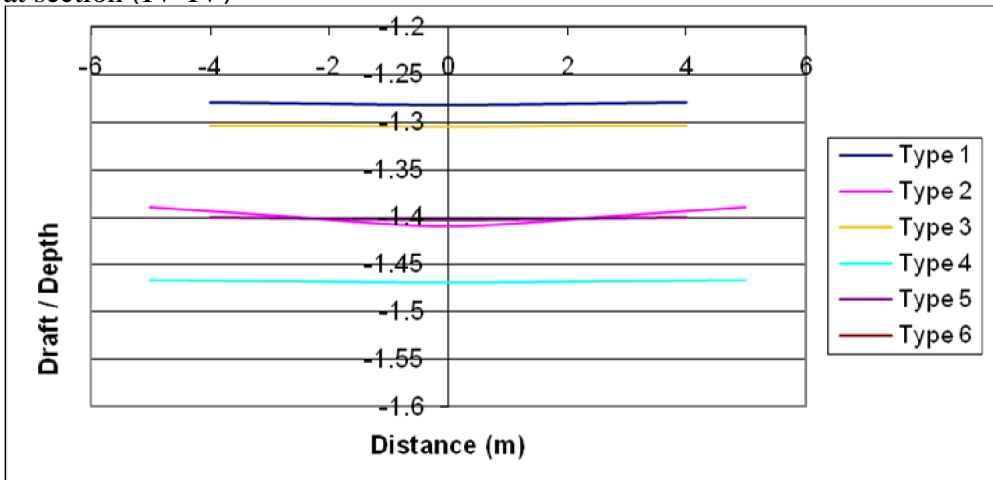

Figure (7.2.21) Draft/depth-distance of the existing and modified ferries under longitudinal eccentricity of 9.0ms at section (V-V)

7.3 Transverse eccentric MLC 70 loading

Continuing the ferry structural analysis, transverse eccentric loading case is performed at middle pontoon of the ferry, with a transverse eccentricity 0.5ms which is the maximum allowed distance on the traffic space (traffic lane) as shown in figure (7.3.1).

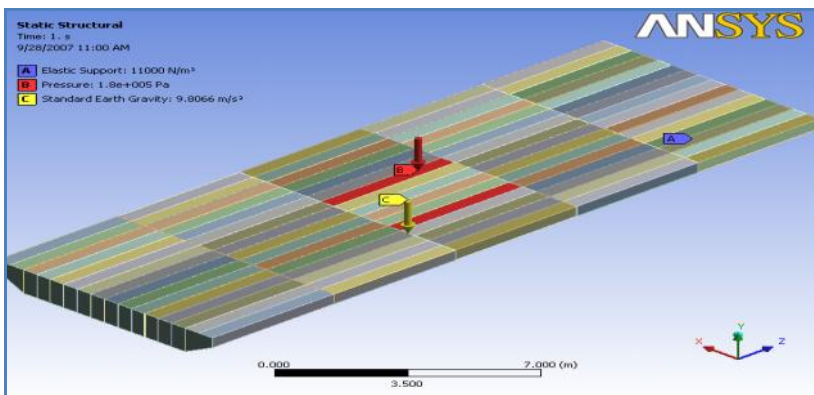

Figure (7.3.1) Inputs of the developed equivalent ferry under transverse eccentric loading of 0.5m

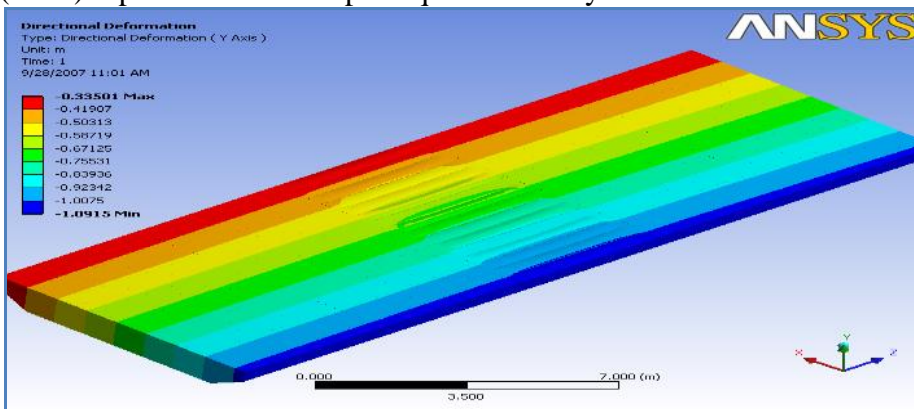

Figure (7.3.2) Draft of type 1 ferry under transverse eccentricity of 0.5ms

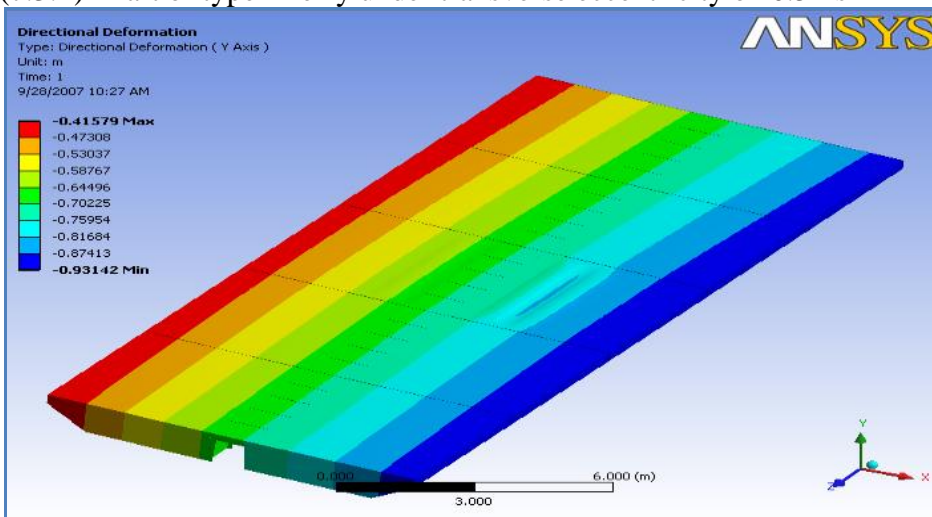

Figure (7.3.3) Draft of type 2 ferry under transverse eccentricity of 0.5ms

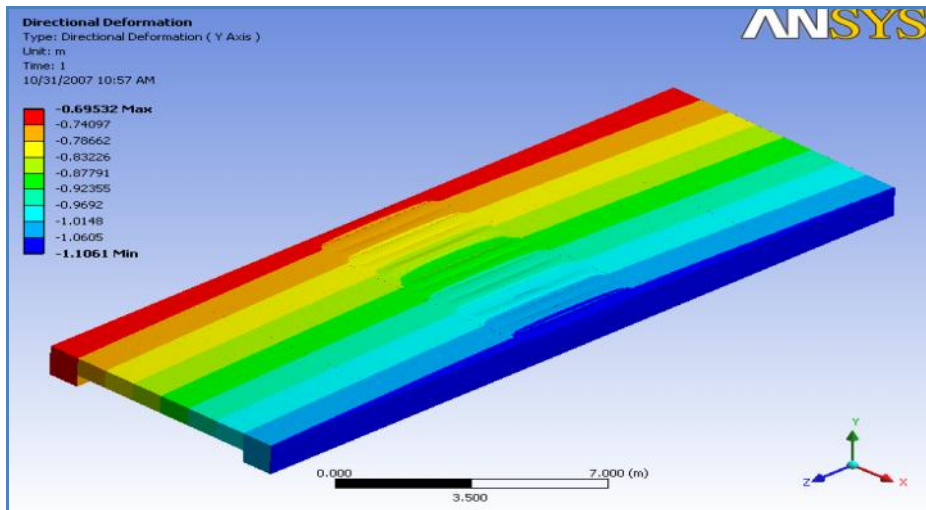

Figure (7.3.4) Draft of type 3 ferry under transverse eccentricity of 0.5ms

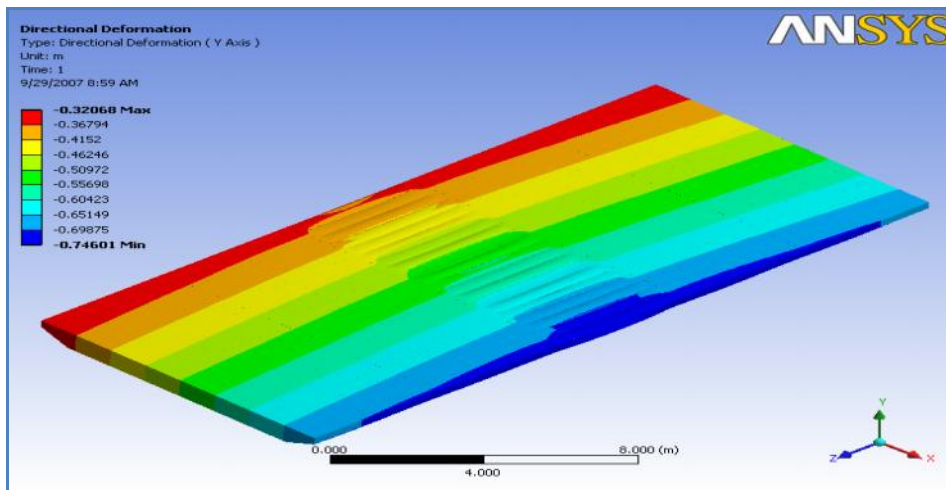

Figure (7.3.5) Draft of type 4 ferry under transverse eccentricity of 0.5ms

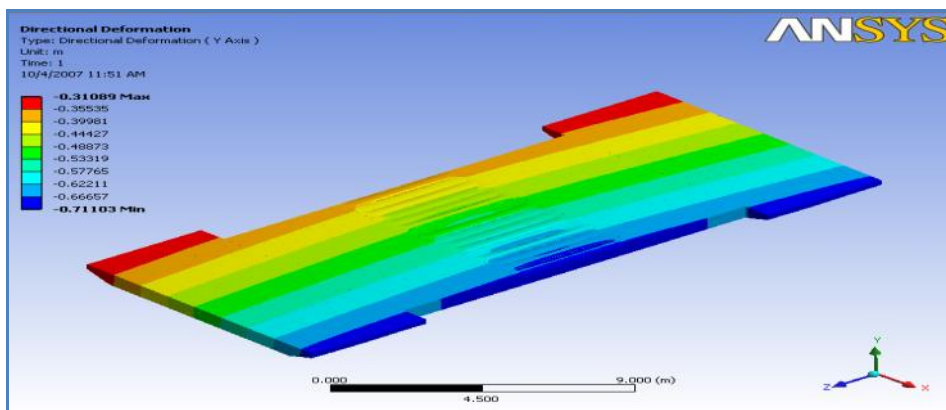

Figure (7.3.6) Draft of type 5 ferry under transverse eccentricity of 0.5ms

The calculated drafts of the five proposals under transverse eccentricity of 0.5ms as shown in figures (7.3.2), (7.3.3), (7.3.4), (7.3.5) and (7.3.6), are found to be 109cms for type (1) which represents

109% of its height, 93cms for type (2) which represents 93% of its height, 110cms for type (3) which represents 88% of its height, 74cms for type (4) which represents 98% of its height, 71cms for type (5) which represents 74.6% of its height. Figures from (7.3.7) to (7.3.11) show draft/depth-distance of the existing and modified ferries under transverse eccentricity of 4.5 ms.

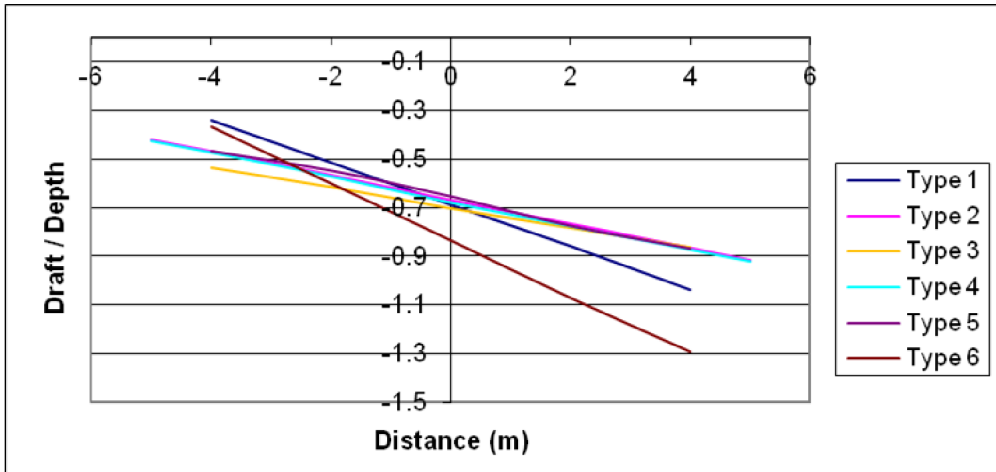

Figure (7.3.7) Draft/depth-distance of the existing and modified ferries under transverse eccentricity of 0.5ms at section (I-I)

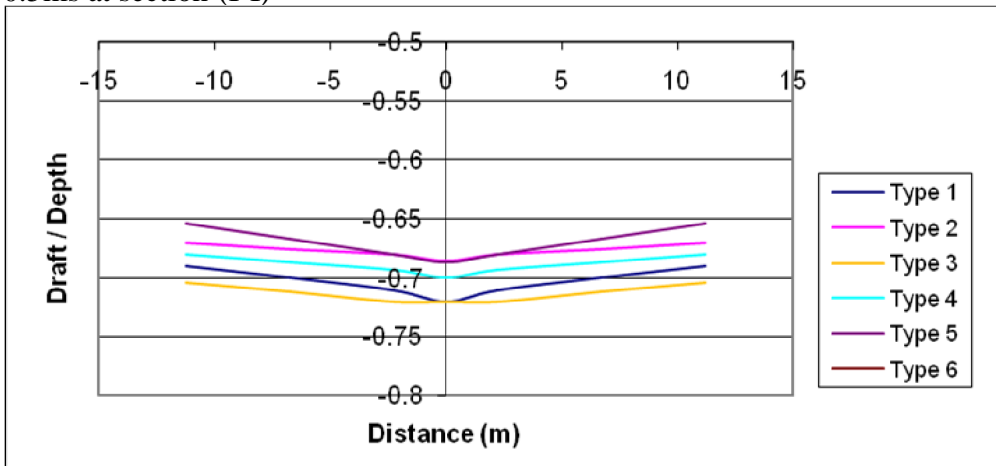

Figure (7.3.8) Draft/depth-distance of the existing and modified ferries under transverse eccentricity of 0.5ms at section (II-II)

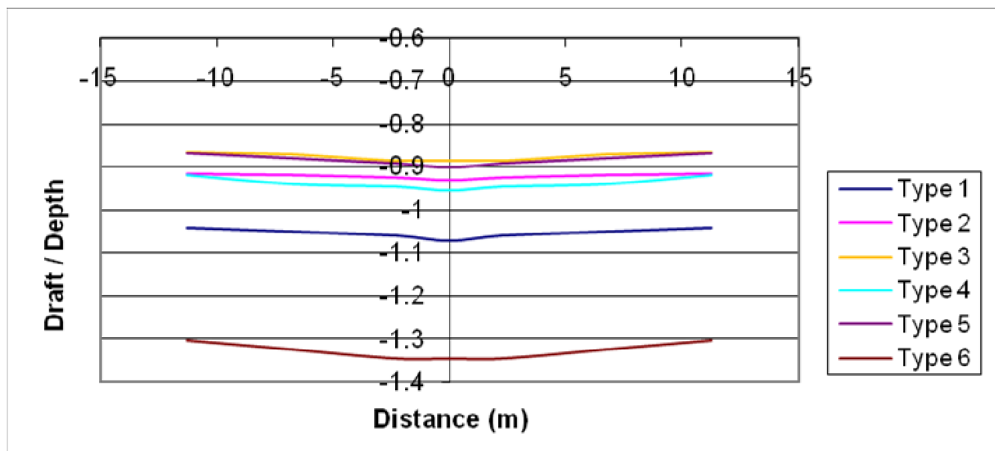

Figure (7.3.9) Draft/depth-distance of the existing and modified ferries under transverse eccentricity of 0.5ms at section (III-III)

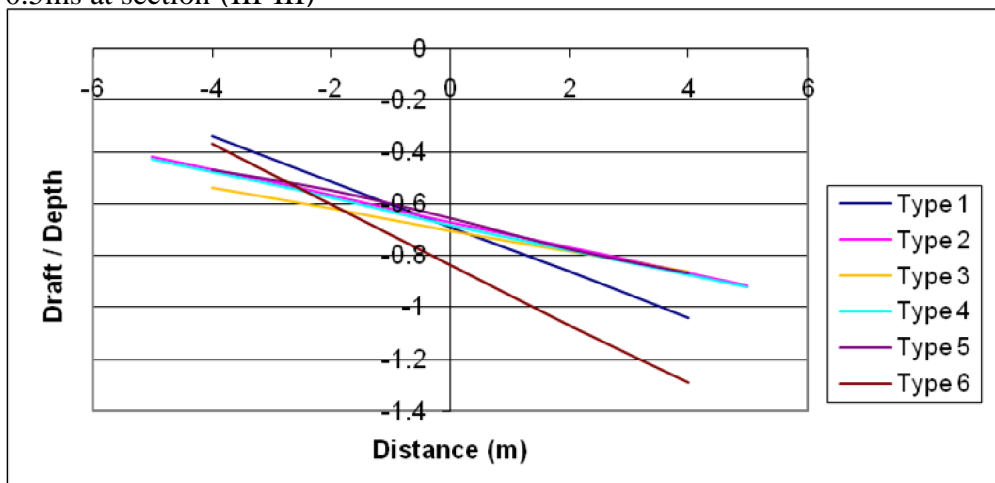

Figure (7.3.10) Draft/depth-distance of the existing and modified ferries under transverse eccentricity of 0.5ms at section (IV-IV)

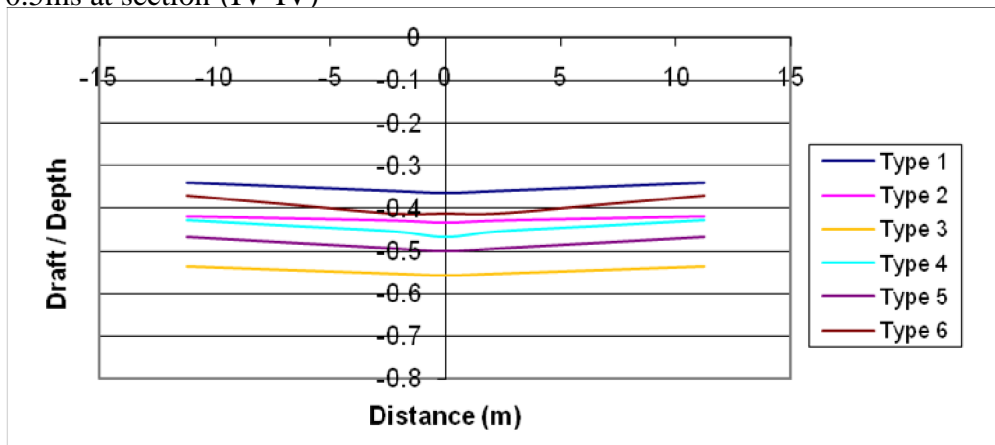

Figure (7.3.11) Draft/depth-distance of the existing and modified ferries under transverse eccentricity of 0.5ms at section (V-V)

7.4 Combined eccentric MLC70 loading

A combined eccentric loading case was chosen at the first pontoon of the ferry with longitudinal eccentricity of 9.0ms and transverse eccentricity of 0.5ms as shown in figure (7.4.1) which is the worst case of loading to be assumed.

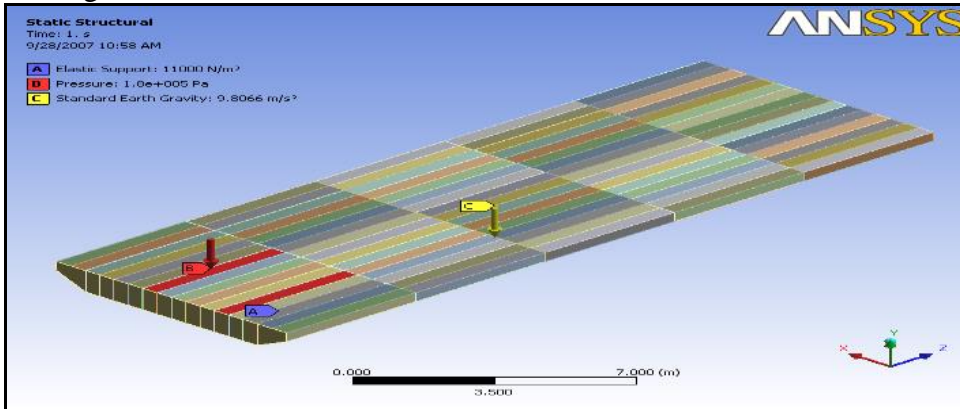

Figure (7.4.1) Inputs of the equivalent ferry under combined eccentric load

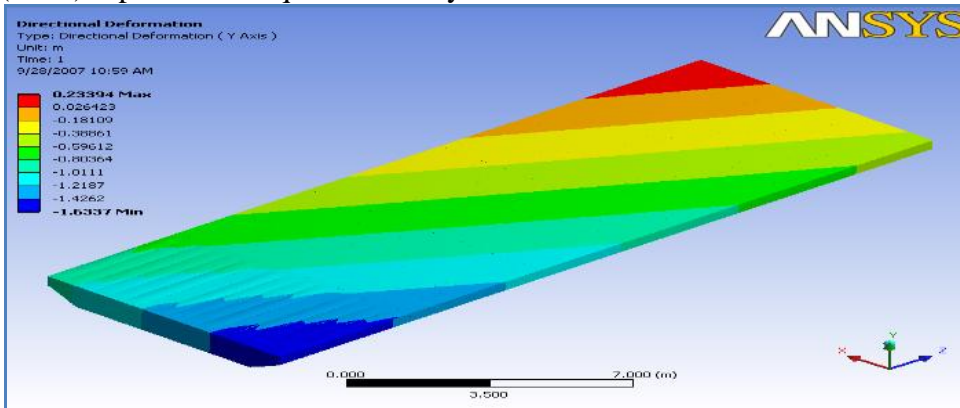

Figure (7.4.2) Draft of type 1 ferry under longitudinal eccentricity of 9.0ms and transverse eccentricity of 0.5ms

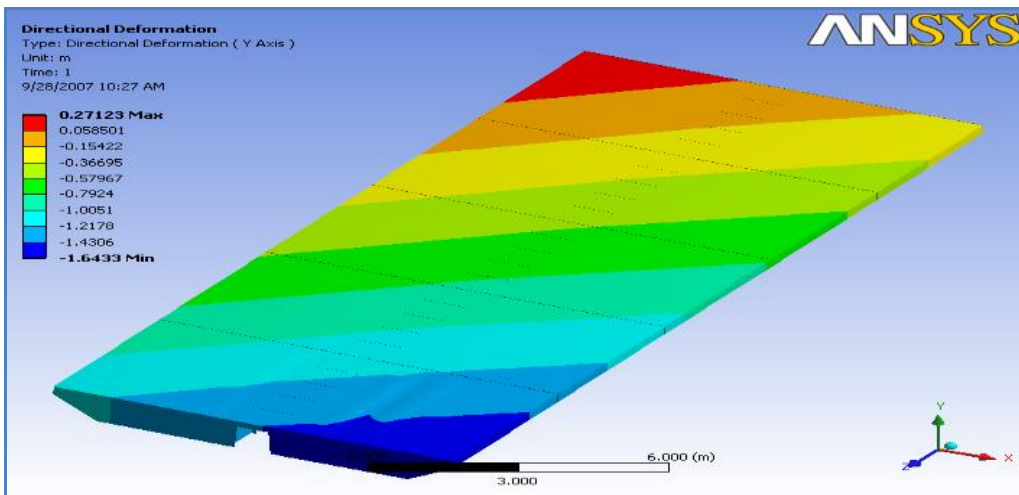

Figure (7.4.3) Draft of type 2 ferry under longitudinal eccentricity of 9.0ms and transverse eccentricity of 0.5ms

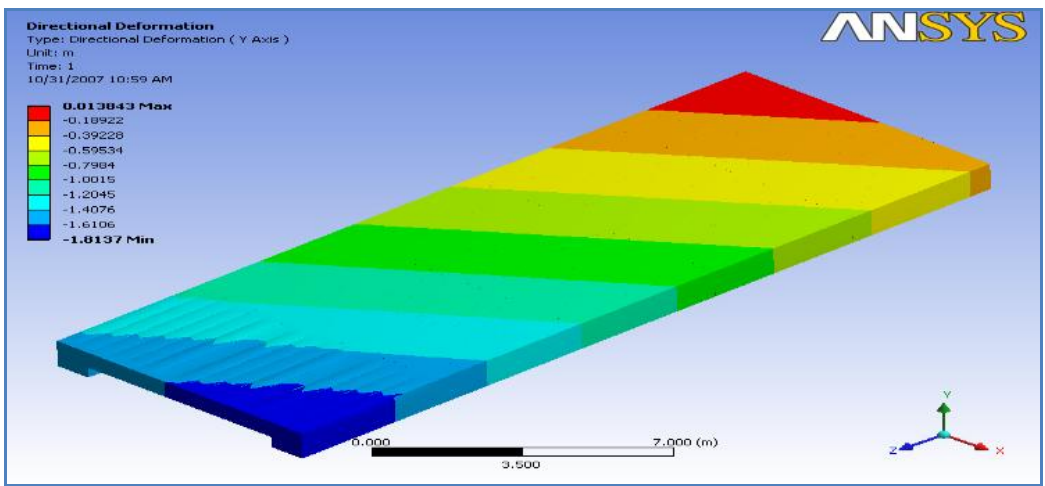

Figure (7.4.4) Draft of type 3 ferry under longitudinal eccentricity of 9.0ms and transverse eccentricity of 0.5ms

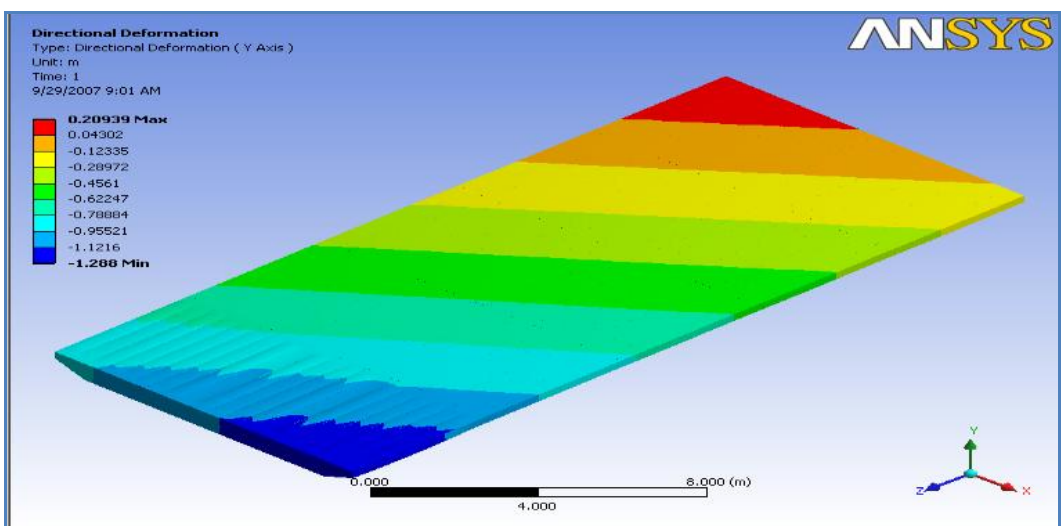

Figure (7.4.5) Draft of type 4 ferry under longitudinal eccentricity of 9.0ms and transverse eccentricity of 0.5ms

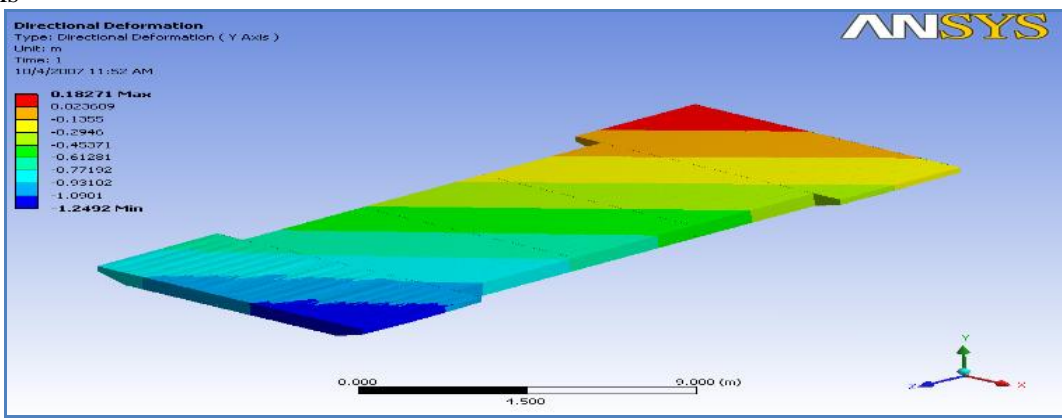

Figure (7.4.6) Draft of type 5 ferry under longitudinal eccentricity of 9.0ms and transverse eccentricity of 0.5ms

As shown in figures (7.4.2), (7.4.3), (7.4.4), (7.4.5) and (7.4.6), the drafts of the five modifications under combined eccentricity are found to be 163cms for type (1) which present 163% of its height, 164cms for type (2) which present 164% of its height, 181cms for type (3) which present 145% of its height, 129cms for type (4) which present 172% of its height, 125cms for type (5) which present 166% of its height. Figures from (7.4.7) to (7.4.11) show draft/depth-distance of the existing and modified ferries under combined eccentricity.

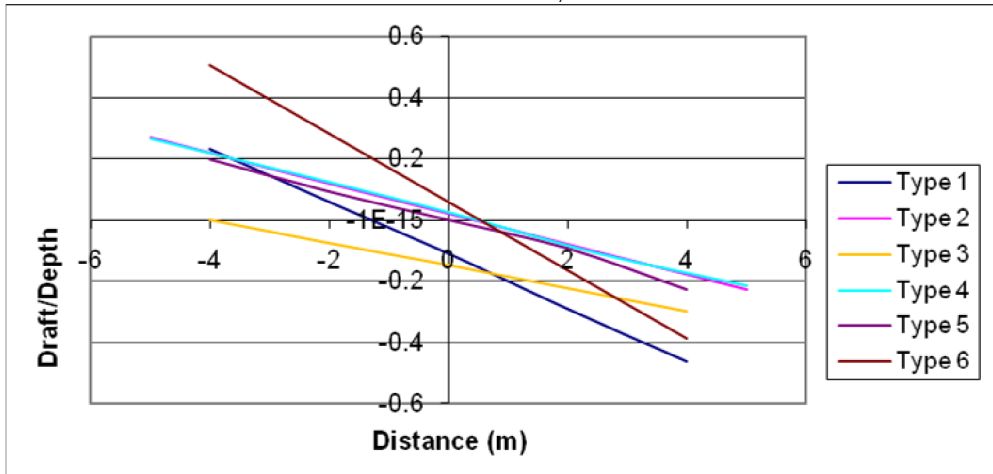

Figure (7.4.7) Draft/depth-distance of the existing and modified ferries under longitudinal eccentricity of 9.0ms and transverse eccentricity of 0.5ms at section (I-I)

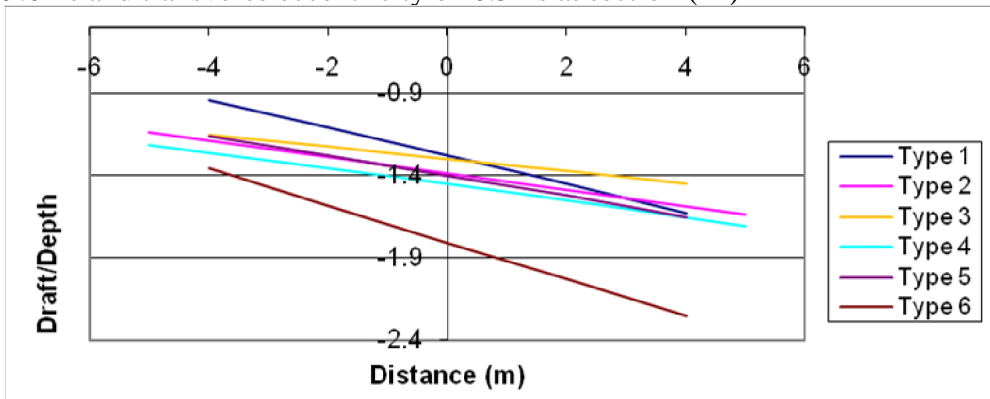

Figure (7.4.8) Draft/depth-distance of the existing and modified ferries under longitudinal eccentricity of 9.0ms and transverse eccentricity of 0.5ms at section (II-II)

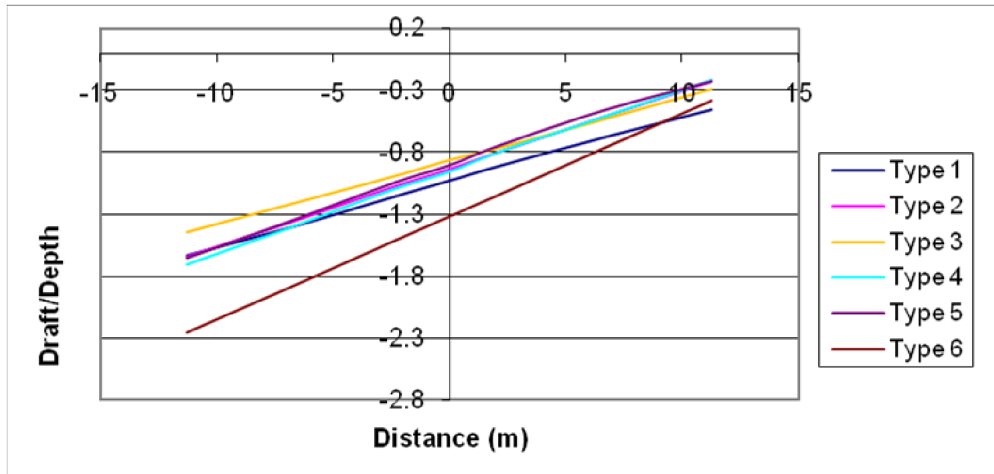

Figure (7.4.9) Draft/depth-distance of the existing and modified ferries under longitudinal eccentricity of 9.0ms and transverse eccentricity of 0.5ms at section (III-III)

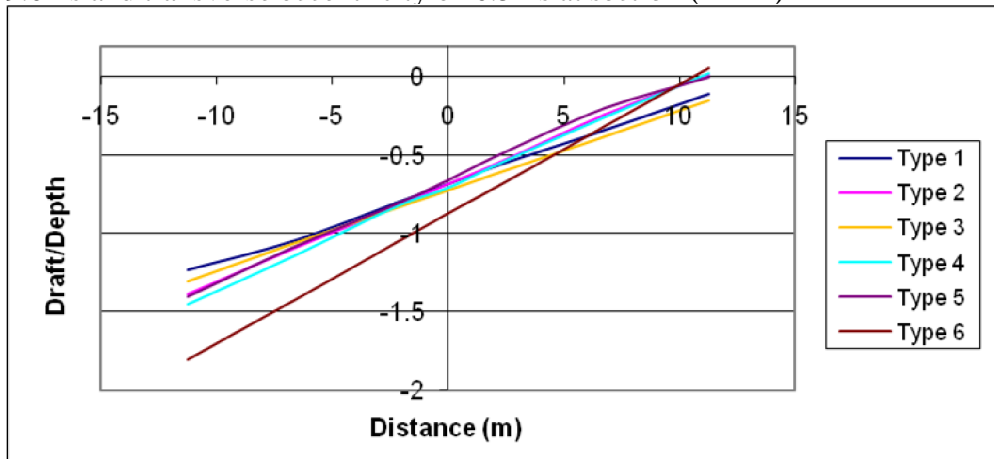

Figure (7.4.10) Draft/depth-distance of the existing and modified ferries under longitudinal eccentricity of 9.0ms and transverse eccentricity of 0.5ms at section (IV-IV)

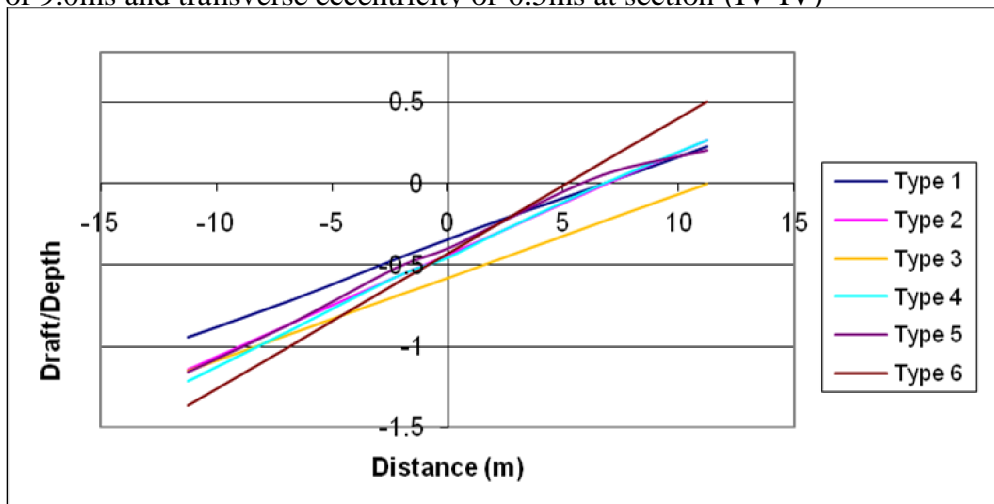

Figure (7.4.11) Draft/depth-distance of the existing and modified ferries under longitudinal eccentricity of 9.0ms and transverse eccentricity of 0.5ms at section (V-V)

8. Comparison analysis for the five types of developed ferries

It is very important to make a comparison between the five proposals of the ferries in order to determine the best method for ferry’s modification. Comparison is done using group of curves which show the draft/depth of each type of the five ferries under each case of concentric, longitudinal eccentric, transverse eccentric and combined eccentric loading.

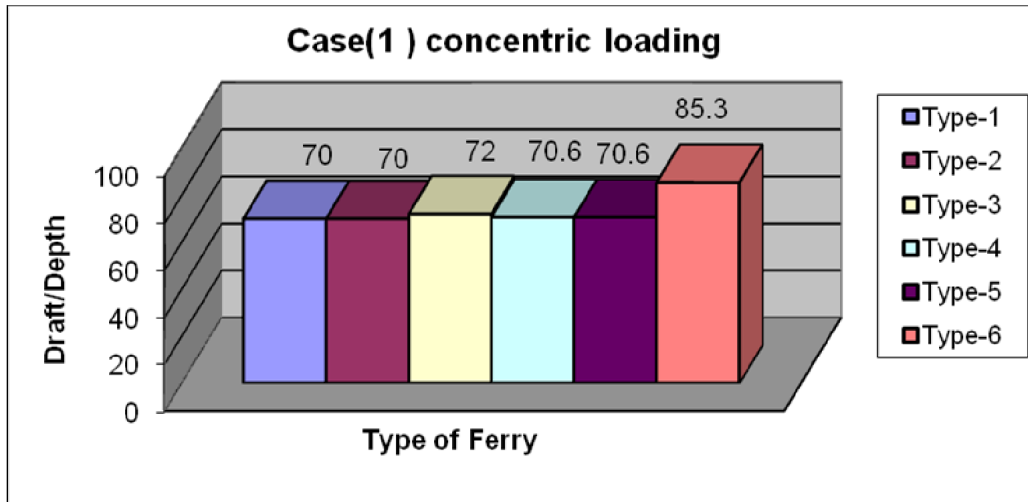

Figure (8.1) Maximum draft/depth % for case 1 of loading

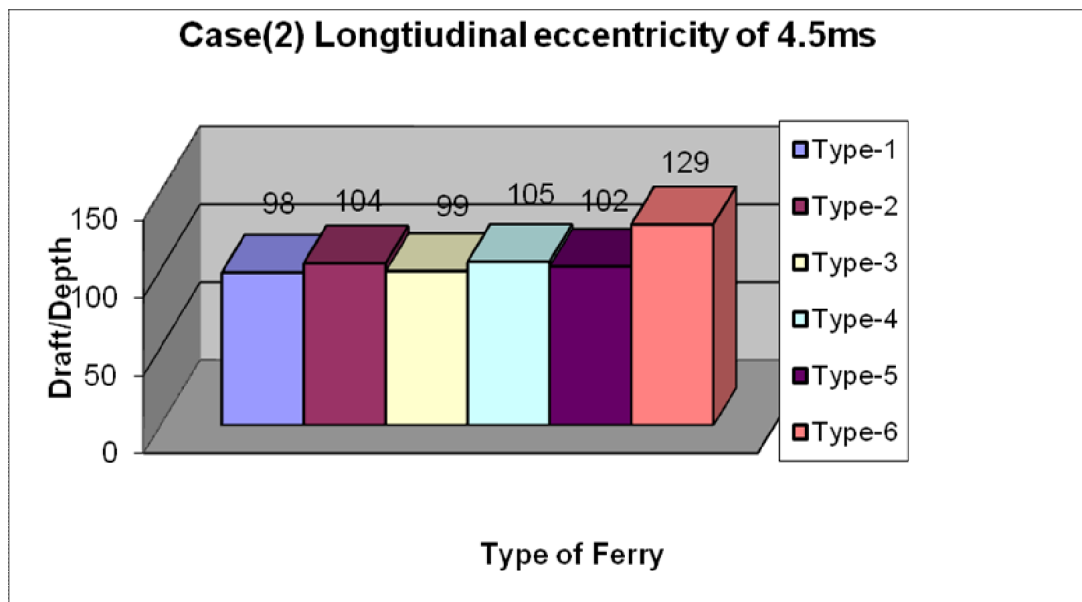

Figure (8.2) Maximum draft/depth % for case 2 of loading

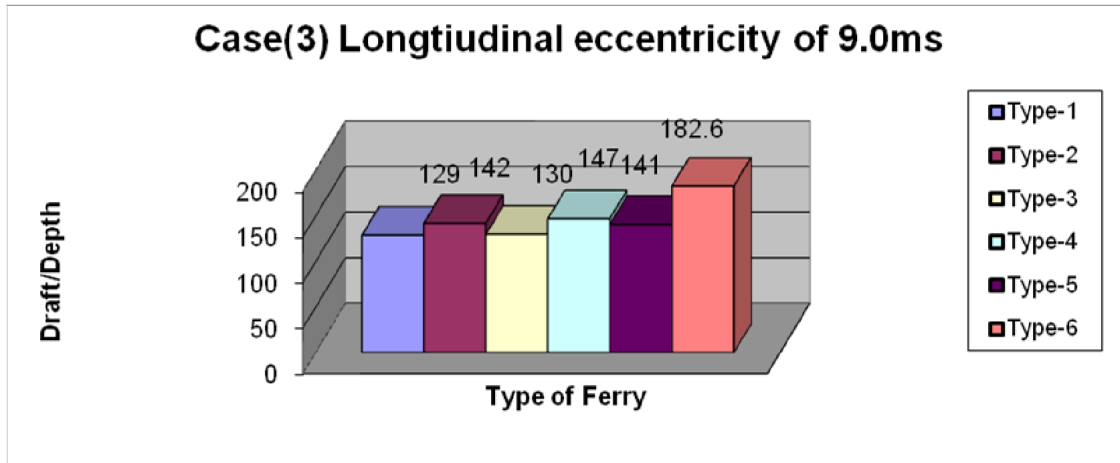

Figure (8.3) Maximum draft/depth % for case 3 of loading

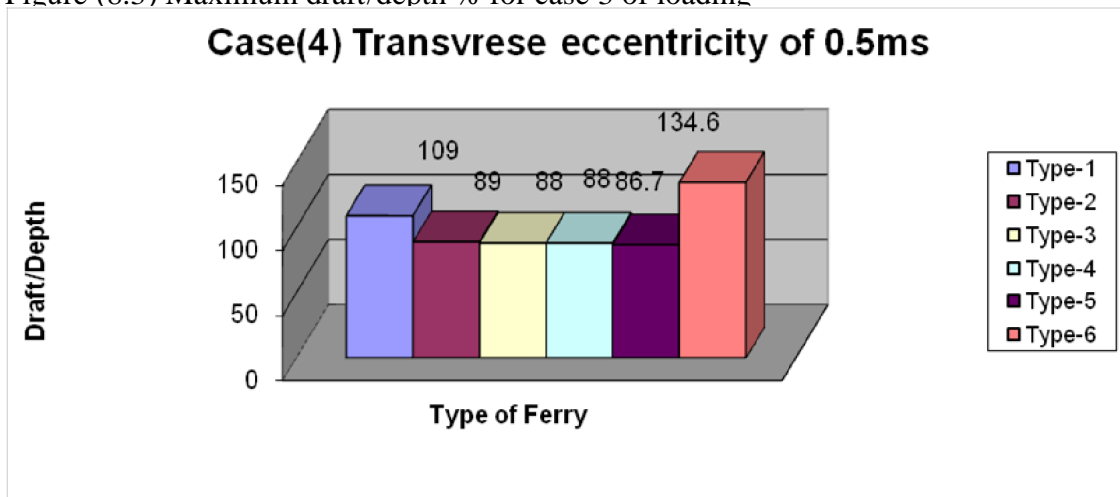

Figure (8.4) Maximum draft/depth % for case 4 of loading

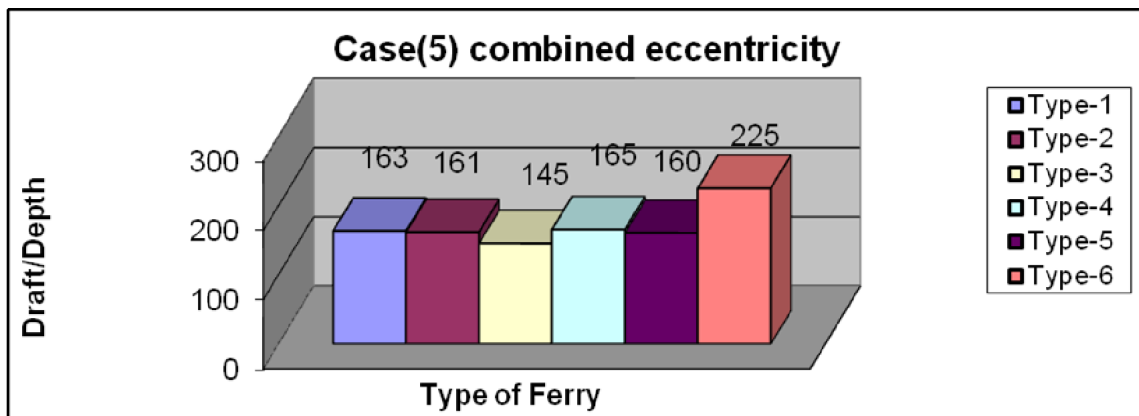

Figure (8.5) Maximum draft/depth % for case 5 of loading

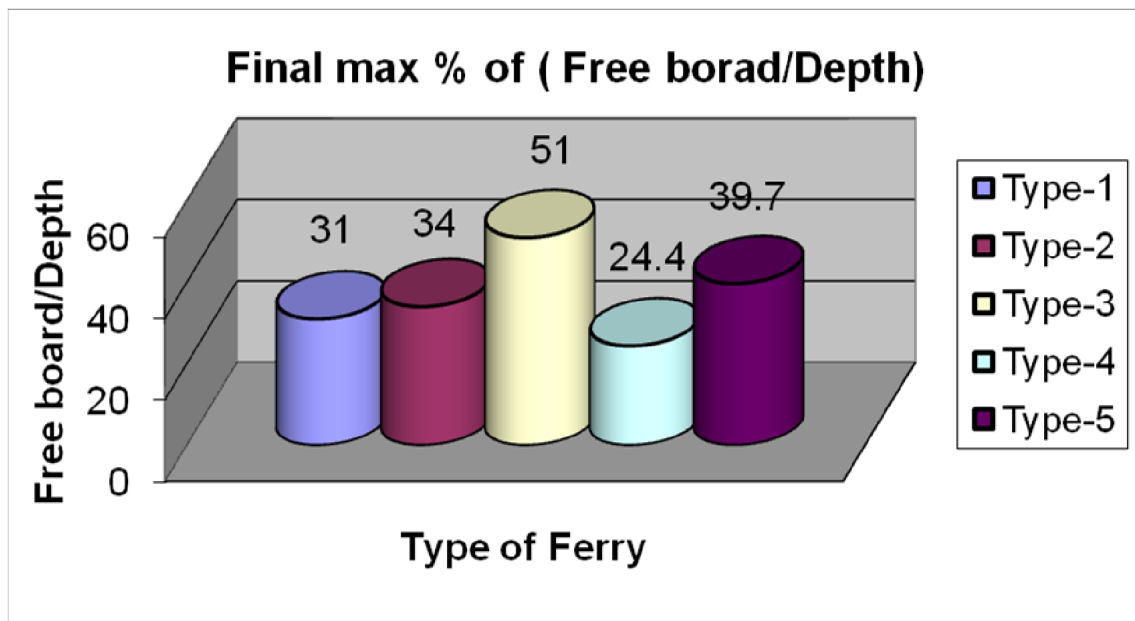

Figure (8.6) Final maximum free board/depth % concluded from all cases of loading

As shown from the comparison figures, type (3) is the best developed ferry modification from stability point of view and type (5) comes next. Type (3) is suitable when designing a new bridge, but for modification issue, type (5) would be more visible and easier.

9. Conclusion

- 1- The 3D finite element modeling is the best method for ferries and floating bridges analysis, as it shows the real behavior of the structure.
- 2- The stability analysis for the five proposed modified ferries showed that type (3) is the most stable model, It reached 51% freeboard/Depth percent as average for all cases of loading carried out.
- 3- In case of modifying an existing floating bridge type (5) can be easier in construction. It took the second place in freeboard/Depth percent 39.7% as average for all cases of loading carried out.

10. References

- [1] Eiichi Watanabe “Floating bridges: past and present”, Structural engineering international (2003).
- [2] M. S. Seif, R. T. Paien Koulaei “Floating bridge modeling and analysis”, Scientia Iranica, 12 (2005) 199-206.
- [3] Richard W. Dean “Amphibious float bridge systems”, SBLM (2002).
- [4] Ehab M. Ebaied “Analysis and design of floating bridges” PhD. Ain Shams University (2007).

- [5] Yasser A. Khalifa "Structural System Effect on the Stability on the Metallic Floating Bridges" Msc. MTC (2008)
- [6] Masahiko Fujikubo, Tetsuya Yao "Structural modeling for global response analysis of VLFS", Marine structures 14 (2001) 259-310.
- [7] Army TM 5-600 "Bridge inspection, maintenance, repair", Department of USA army (1994).
- [8] Army FM 90-13 "River crossing operations", Department of USA army (1992).
- [9] "Trilateral Design and Test Code for Military Bridging and Gap -Crossing Equipments", Department of USA army (1996).